

autolamps

A Clarience Technologies Company



PATCH HARNESS SYSTEMS
A CABLE SOLUTION FOR ALL YOUR NEEDS

Version 5.7 - 2024

Functional, Long Lasting OEM Quality



Easy Lighting Upgrade for Trays

Upgrading or fitting LED rear lighting to trays has never been made easier with our new plugin lamp and patch cable system. We have made available our most popular rear combination lamps that have been prewired with load resistors assisting with fast flashing indicators or error messages and terminated with quality Deutsch connectors. The key is to adapt to the vehicles' existing harness system with the additional capability to adapt to our existing plugin marker and licence plate lamps. Benefits include no soldering, leading to an increase in productivity, saving time and money. Our comprehensive range of vehicle patch cable adapter plugs suiting most popular branded vehicles will not disappoint.



Bullbar LED Upgrade

The patch harness system makes upgrading or fitting LEDs to vehicle bullbars easy by offering our most popular front position/indicator lamps and having them prewired with the suitable harness and O.E.M. vehicle connectors. The key is the ability to adapt to the vehicles' existing harness system. D.I.Y. installers can also benefit, allowing fabricators to send completed bars out to their customers. With our comprehensive range of vehicle patch cable adapters suiting the most popular branded vehicles, a solution to almost any application is available.



- Add any Light Anywhere in the Harness System
- Easily replace damaged lighting with minimal downtime
- Heavy Duty Waterproof Cable, Plugs and Connectors
- System Adaptability and Customisation
- All Lights Compliant with ECE or ADR
- RoHS Compliant Cables, Plugs and Lights

Rear Patch System
Page 4-5



Lamps and Accessories
Page 6-11



Front Indicators
Page 12-13



Driving Lamps
Page 14-15





System Functionality and Adaptability

Explicitly designed to be easily and quickly installed without the need to cut, splice, solder, join or tape wire joins. This patch harness system will reduce fitting times which in turn saves fitters time and money. This patch system is ever-expanding with new brands and adaptability to suit. We can also help with bespoke, custom OE or specific requirements making the process entirely adaptable for your particular needs.



Side Indicator Upgrade

We have made available our most popular category six side direction indicator prewired with a suitable harness and O.E.M. vehicle connectors. A GVM upgrade or a new installation, fitting a category 5/6 approved side direction indicator to a vehicle, has never been made easier with our new plugin lamp and patch cable system. The key is the ability to adapt to the vehicles' existing harness system. With our comprehensive range of vehicle patch cable adapter plugs suiting most popular branded vehicles, you will not be disappointed with the choice.



Driving Light Compatibility

Driving Lighting upgrades has never been made easier with our new plugin lamp and patch cable system. The connection requires virtually no wiring using the vehicle-specific patch cable to tap into and isolate the high beam signal. We offer an extensive range of vehicle patch cable adapters serving the most popular branded vehicles, and you will be satisfied with the options available.



Rigid Body Harnessing System

Our research and development team continually adapt to keep up with as many vehicles as possible. The Rigid body trucks can also benefit from this system, with numerous possibilities to advance your Lighting and wiring options.

Side Direction
Page 16-17

Brand Adaptability
Page 18-37

Rigid Body Kits
Page 38-61

Plugs & Connectors
Page 62-65





Designed for Tray Type Vehicles

Upgrading or fitting trays to LED rear lighting has never been made easier with our new plugin lamp and patch cable system. We have made available our most popular rear combination lamps that have been prewired with load resistors assisting with fast flashing indicators or error messages and terminated with quality Deutsch connectors.

- 1** Vehicle Factory Loom
- 2** Vehicle Patch Lead
- 3** Rear Combination Lamp

Compatible with the following brands

- Suits Holden Colorado
- Suits Nissan Navara
- Suits Toyota Landcruiser
- Suits Dodge Ram 1500
- Suits Hino Trucks

- Suits Mazda BT-50
- Suits Ford Ranger
- Suits Volkswagen Amarok
- Suits Isuzu Trucks
- Suits Toyota Hilux

- Suits Mitsubishi Triton
- Suits Isuzu D-MAX
- Suits LDV T60/T70
- Suits Fuso Trucks
- Suits LDV

- Suits Dodge
- Suits Great Wall
- Suits Holden
- Suits Many More



Flexibility for any Application or Wiring Requirements

The key is the ability to adapt to the vehicles' existing harness system. With our comprehensive range of vehicle patch cable adapter plugs suiting most popular branded vehicles, you will not be disappointed with the choice. A handy additional feature is the ability to adapt to our existing plugin marker and licence plate lamps. To complete the system, we also have an extensive range of separate patch plugs and connectors. We can also help with bespoke, custom OE or specific requirements as well.



Prewired Lamp and patch lead to vehicle loom

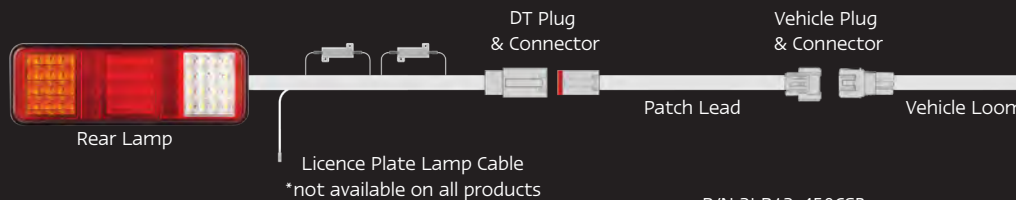

Prewired CSB Lamp and patch lead to vehicle loom



Prewired Lamp and hard wire to vehicle loom

FOR VEHICLES WHERE A PATCH IS NOT AVAILABLE.

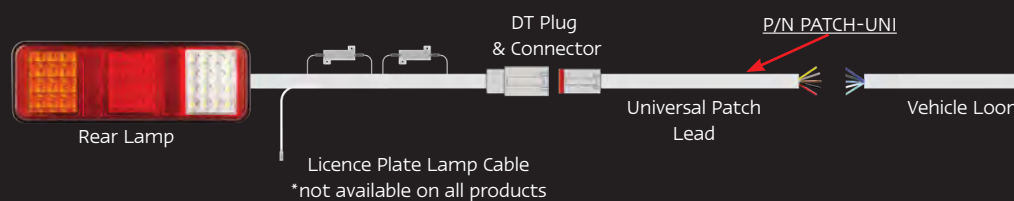

LED Lamp with bare ends and patch lead to vehicle loom

FOR ADAPTING LIGHTS THAT ARE NOT AVAILABLE WITH PRE-TERMINATED PLUGS

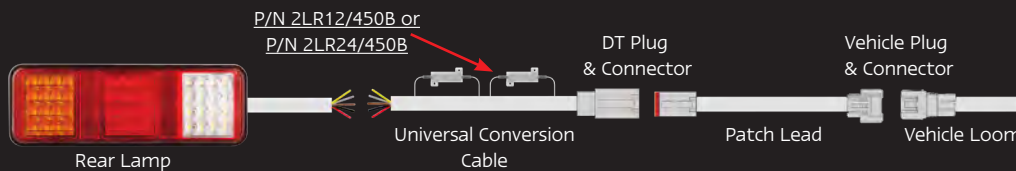

Warning: The resistors/modules can reach temperatures up to 170°C, do not mount the resistor on any surface that can be melted by the heat of the resistor, this includes plastics, hoses or painted surfaces.

Rear Combination Lamps

Note: When using load resistors in a vehicle that has lamp failure monitoring, failure of the lamp will not be detected.



282 Series - SIZE 284MM x 100MM x 27MM

Part No	Voltage	Function	Cable
S0282ARWM2LR450	12 VOLT	STOP/TAIL/INDICATOR/REVERSE	450MM WITH 2 x 12V RESISTORS, TERMINATED WITH DEUTSCH CONNECTOR AND 500MM LICENCE PLATE CABLE WITH 2 PIN MALE PLUG

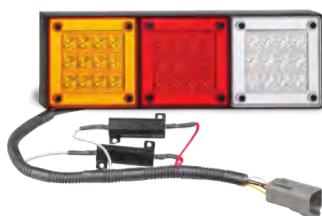

280 Series - SIZE 282MM x 95MM x 28MM

Part No	Voltage	Function	Cable
280ARWM2LR12/450	12 VOLT	STOP/TAIL/INDICATOR/REVERSE COLOURED LENS	450MM WITH 2 x 12V RESISTORS, TERMINATED WITH DEUTSCH CONNECTOR
280ARWM2LR24/450	24 VOLT	STOP/TAIL/INDICATOR/REVERSE COLOURED LENS	450MM WITH 2 x 24V RESISTORS, TERMINATED WITH DEUTSCH CONNECTOR
280TARWM2LR12-450	12 VOLT	STOP/TAIL/INDICATOR/REVERSE TINTED LENS COLOURED LEDs	450MM WITH 2 x 12V RESISTORS, TERMINATED WITH DEUTSCH CONNECTOR



250 Series - SIZE 250MM x 80MM x 24MM

Part No	Voltage	Function	Cable
S0250ARWM2LR450	12 VOLT	STOP/TAIL/INDICATOR/REVERSE/REFLECTOR	450MM WITH 2 x 12V RESISTORS, TERMINATED WITH DEUTSCH CONNECTOR AND 500MM LICENCE PLATE CABLE WITH 2 PIN MALE PLUG



82 Series - SIZE 281MM x 101MM x 30MM (CLEAR LENS COLOURED LEDs)

Part No	Voltage	Function	Cable
S082BARWCC2LR12	12 VOLT	STOP/TAIL/INDICATOR REVERSE WITH LICENCE PLUG	450MM WITH 2 x 12V RESISTORS, TERMINATED WITH DEUTSCH CONNECTOR & 500MM LICENCE CABLE WITH 2 PIN MALE PLUG
S082BARWCC2LR12-1	12 VOLT	STOP/TAIL/INDICATOR REVERSE	450MM WITH 2 x 12V RESISTORS, TERMINATED WITH DEUTSCH CONNECTOR (DOES NOT HAVE LICENCE CABLE WITH PLUG)



275 Series - SIZE 275MM x 100MM x 33MM

Part No	Voltage	Function	Cable
S0275GARWM2LR450 275GARWM2LR21W450	12 VOLT	STOP/TAIL/INDICATOR/REVERSE/REFLECTOR	450MM WITH 2 x 12V RESISTORS, TERMINATED WITH DEUTSCH CONNECTOR AND 500MM LICENCE PLATE CABLE WITH 2 PIN MALE PLUG.(275GARWM2LR21W450 - 21 WATT LOAD RESISITOR)

Rear Combination Lamps

Note: When using load resistors in a vehicle that has lamp failure monitoring, failure of the lamp will not be detected.



283 Series - SIZE 283MM x 100MM x 25MM

Part No	Voltage	Function	Cable
S0283ARWM2LR12	12 VOLT	STOP/TAIL/IND/REV/REFLECTOR	450MM WITH 2 x RESISTORS, TERMINATED WITH DEUTSCH CONNECTOR AND 500MM LICENCE PLATE CABLE WITH 2 PIN MALE PLUG
S0283ARWM2LR24	24 VOLT	STOP/TAIL/IND/REV/REFLECTOR	450MM WITH 2 x RESISTORS, TERMINATED WITH DEUTSCH CONNECTOR AND 500MM LICENCE PLATE CABLE WITH 2 PIN MALE PLUG



284 Series - SIZE 284MM x 100MM x 37MM

Part No	Voltage	Function	Cable
S0284LHS	12 VOLT	STOP/DIFFUSED TAIL/SEQUENTIAL IND/REV/REFLECTOR, LEFT SIDE	450MM WITH 2 x 12V RESISTORS, TERMINATED WITH DEUTSCH CONNECTOR AND 500MM LICENCE PLATE CABLE WITH 2 PIN MALE PLUG.
S0284RHS	12 VOLT	STOP/DIFFUSED TAIL/SEQUENTIAL IND/REV/REFLECTOR, RIGHT SIDE	450MM WITH 2 x 12V RESISTORS, TERMINATED WITH DEUTSCH CONNECTOR AND 500MM LICENCE PLATE CABLE WITH 2 PIN MALE PLUG.

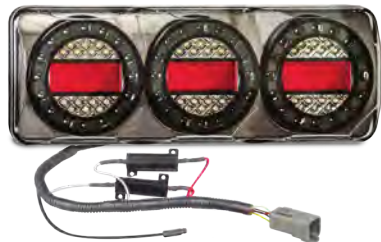

Maxilamp Series - SIZE 370MM x 135MM x 40MM

Part No	Voltage	Function	Cable
S0MAXI2LR/450B	12 VOLT	STOP/TAIL/INDICATOR/REVERSE/REFLECTOR	450MM WITH 2 x 12V RESISTORS, TERMINATED WITH DEUTSCH CONNECTOR AND 500MM LICENCE PLATE CABLE WITH 2 PIN MALE PLUG.

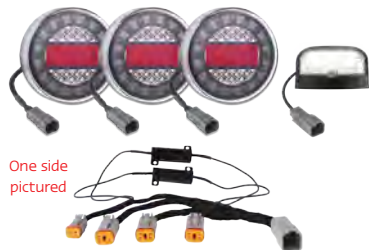

One side pictured

Maxilamp Rear Combo Kit - REAR LAMP SIZE 125MM ROUND x 40MM

Part No	Voltage	Function	Cable
PNPK-MAXI1XR INCLUDES BOTH SIDES	12 VOLT	STOP/TAIL/INDICATOR/REVERSE/LICENCE LAMP AND CABLE KIT	PLUG & PLAY KIT - MAXILAMP C1RXRE x4, MAXILAMP C1XRE x2, 41BLMDT x2, 4x LR12, DT CONNECTORS.

Rear Combination Lamps

Note: When using load resistors in a vehicle that has lamp failure monitoring, failure of the lamp will not be detected.



355 Series - SIZE 356MM x 86MM x 35MM

Part No	Notes	Function
355ARWMLCSB	LEFT HAND SIDE	CHROME LENS, STOP/DIFFUSED TAIL/SEQUENTIAL INDICATOR/REVERSE/REFLECTOR
355ARWMRCSB	RIGHT HAND SIDE	



355 Series - SIZE 356MM x 86MM x 35MM

Part No	Notes	Function
355BARWMLCSB	LEFT HAND SIDE	BLACK LENS, STOP/DIFFUSED TAIL/SEQUENTIAL INDICATOR/REVERSE/REFLECTOR
355BARWMRCSB	RIGHT HAND SIDE	



385 Series - SIZE 387MM x 105MM x 30.5MM

Part No	Notes	Function
385ARWMLCSB	LEFT HAND SIDE	STOP/DIFFUSED TAIL/SEQUENTIAL INDICATOR/REVERSE
385ARWMRCSB	RIGHT HAND SIDE	



3851 Series - SIZE 387MM x 105MM x 30.5MM

Part No	Notes	Function
3851ARWMLCSB	LEFT HAND SIDE	STOP/TAIL/INDICATOR/REVERSE/REFLECTOR
3851ARWMRCSB	RIGHT HAND SIDE	



3852 Series - SIZE 387MM x 105MM x 30.5MM

Part No	Notes	Function
3852ARWMLCSB	LEFT HAND SIDE	STOP/DIFFUSED TAIL/INDICATOR/REVERSE
3852ARWMRCSB	RIGHT HAND SIDE	



3853 Series - SIZE 387MM x 105MM x 30.5MM

Part No	Notes	Function
3853ARWMLCSB	LEFT HAND SIDE	STOP/DIFFUSED TAIL/SEQUENTIAL INDICATOR/REVERSE
3853ARWMRCSB	RIGHT HAND SIDE	



3854 Series - SIZE 387MM x 105MM x 30.5MM

Part No	Notes	Function
3854ARWMLCSB	LEFT HAND SIDE	STOP/DIFFUSED TAIL/SEQUENTIAL INDICATOR/REVERSE
3854ARWMRCSB	RIGHT HAND SIDE	



3855 Series - SIZE 387MM x 105MM x 30.5MM

Part No	Notes	Function
3855ARWMLCSB	LEFT HAND SIDE	STOP/DIFFUSED TAIL/INDICATOR/REVERSE
3855ARWMRCSB	RIGHT HAND SIDE	

Rear Lamps, Licence Plate, Reverse Lamps and Accessories

Note: When using load resistors in a vehicle that has lamp failure monitoring, failure of the lamp will not be detected.



3856 Series - SIZE 387MM x 105MM x 30.5MM

Part No	Notes	Function
386ARWMLCSB	LHS	STOP/DIFFUSED TAIL/INDICATOR/REVERSE
386ARWMRCB	RHS	



CSB Adapter Patch Lead

Part No	Notes	Function
2LR12-450CSB	12 VOLT	ADAPTS OUR 7 CORE CSB LAMPS TO WORK WITH OUR TAIL LAMP PATCH SYSTEM. VOLTAGE SPECIFIC.
2LR24-450CSB	24 VOLT	(2LR21W-450CSB - 21 WATT LOAD RESISTOR)
2LR21W-450CSB	12 VOLT	

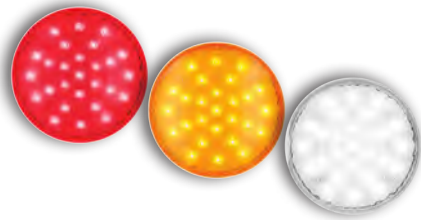

110 Series Single Function

Part No	Function
110RMB	STOP/TAIL
110AMB	INDICATOR
110WMB	REVERSE



130 Series Single Function

Part No	Function
130RMB	STOP/TAIL/REFLECTOR
130AMB	INDICATOR
130WMB	REVERSE



Single Function Grommets

Part No	Function
53401	ROUND RUBBER GROMMET
59401	RECTANGLE RUBBER GROMMET

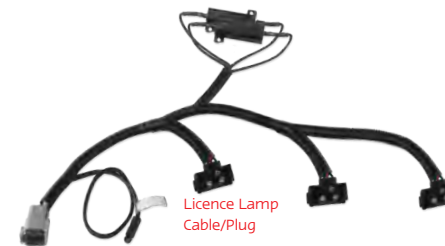

Single Function Adapter

Part No	Function
3PSTIR-2LR12-450B	53102x3, DT04-6P, 2x 12V RESISTORS, 450MM LENGTH.



11 Series - SIZE 89MM x 30MM x 8MM

Part No	Function
11WM-2AMP	REVERSE LAMP WITH 25CM CABLE AND 2AMP PLUG, 12-24V



Bracket - SIZE 228MM x 215MM

Part No	Function
LC300REVBKT	REVERSE LAMP ALLOY SINGLE TAILGATE MOUNTING BRACKET



Reverse Adapter Patch Lead

Part No	Function
LC300TGL00M	REVERSE LAMP TAILGATE HARNESS

Note: Currently only available for the Landcruiser300 Series See page 28 for more information

Rear Lamps, Licence Plate, Reverse Lamps and Accessories

Note: When using load resistors in a vehicle that has lamp failure monitoring, failure of the lamp will not be detected.



Work/Reverse Lamp

Part No	Function
7312BMCSB	FLOOD LAMP WITH 2 CORE FEMALE PLUG 12-24V



Universal Patch Cable

Part No	Function
PATCH-UNI	PAIR OF UNIVERSAL PATCH LEAD DT06 AND BARE WIRES FOR HARD WIRE



Reverse Beeper/Squawker

Part No	Function
2PF200RAB	REVERSE BEEPER 12-24V 200MM CABLE 102DB FIXED
2PF200ETB	REVERSE BEEPER 12-24V 200MM CABLE 102DB FIXED
2PF200SQB	REVERSE SQUAWKER 12-24V 200MM CABLE 102DB FIXED



Patch Relay

Part No	Function
PATCH-RELAY	PAIR OF 4-PIN RELAY WITH 450MM CABLE AND DT04-4P PLUG



Reverse Breakout Patch

Part No	Function
BOPATCH-REVCSB	DEUTSCH EXTENSION WITH 2 CORE CABLE WITH 500MM CABLE WITH MALE PLUG FOR REVERSE

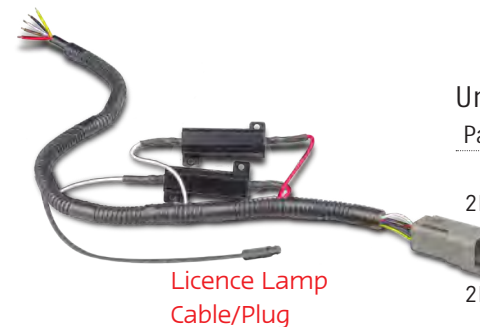

Universal Lamp Patch Cable

Part No	Function
2LR12/450B	450MM LENGTH. 2 x 12V RESISTORS. BARE WIRES AND DT04-6P CONNECTOR.
2LR24/450B	450MM LENGTH. 2 x 24V RESISTORS. BARE WIRES AND DT04-6P CONNECTOR.

Rear Lamps, Licence Plate, Reverse Lamps and Accessories

Note: When using load resistors in a vehicle that has lamp failure monitoring, failure of the lamp will not be detected.



Licence Plate Resistor

Part No	Function
2PM.5LP	T10 TO 2 PIN MALE PLUG (PAIR) 12V ONLY



Licence Plate Resistor

Part No	Function
2PM.5LPDT	DEUTSCH PLUGS (PAIR) 12V ONLY



Licence Plate Lamp

Part No	Function
35BLMCSB	LICENCE PLATE LAMP 12-24V, 20CM CABLE AND FEMALE PLUG



Licence Plate Lamp

Part No	Function
41BLMCSB	LICENCE PLATE LAMP 12-24V, 20CM CABLE AND FEMALE PLUG



Licence Plate Lamp

Part No	Function
6434BW-MCSB	LICENCE PLATE LAMP 12-24V, 20CM CABLE AND FEMALE PLUG
6434CW-MCSB	CHROME LICENCE PLATE LAMP 12-24V, 20CM CABLE AND FEMALE PLUG

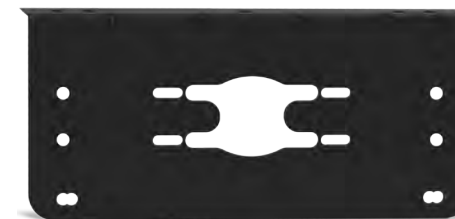

Multi-Fit Bracket

Part No	Function
MFBKT	MULTI FIT STEEL BRACKET SUITS, 280, 282, 275, 80, 283, 284, TRIPLE COMBINATION LAMPS



Bullbar Patch System for Front Position & Indicators

The patch harness system makes upgrading or fitting LEDs to vehicle bullbars easy by offering our most popular front position/indicator lamps and having them prewired with the suitable harness and O.E.M. vehicle connectors. The key is the ability to adapt to the vehicles existing harness system. D.I.Y. installers can also benefit, allowing fabricators to send completed bars out to their customers. With our comprehensive range of vehicle patch cable adapters suiting the most popular branded vehicles, a solution to almost any application is available.

- Upgrade From Globe Type
- Reduce Bar Fitment Time
- New O/E Installation
- Evolving Brand Compatibility



Daytime Running Lamps and DRL Module

When used in conjunction with the below lamps, this module converts the lamp to operate as an ECE Approved Daytime Running Lamp. Requires one for each lamp. Voltage Range 9-30 Volt.



Part No	Function
BBPATCH-DRLHD3AMP	DRL WIRING CONVERTER, COMPATIBLE WITH BBPATCH SYSTEM, 3 AMP PLUGS.200MM CABLE EACH SIDE.
BBPATCH-DRLHD4AMP	DDRL WIRING CONVERTER, COMPATIBLE WITH BBPATCH SYSTEM, 4 AMP PLUGS.200MM CABLE EACH SIDE.

175AWTB Series - SIZE 225MM X 56MM X 27MM

Part No	Voltage	Function	Cable
175AWTB-3AMP	12V	FRONT INDICATOR/ POSITION/DRL WITH BBPATCH-DRLHD3AMP	20CM WITH AMP PLUG



80 Series - SIZE 80MM ROUND X 40MM

Part No	Voltage	Function	Cable
80AW-3AMP	12V	FRONT INDICATOR/ POSITION/DRL WITH BBPATCH-DRLHOTDOG	20CM WITH AMP PLUG



Pre-wired Lamps with 3 Pin AMP Plug

135 Series - SIZE 135MM x 38MM x 24MM



Part No	Voltage	Function	Cable
135AW-3AMP	12V	FRONT INDICATOR/ POSITION, BRACKET	20CM WITH AMP PLUG
135AWG-3AMP	12V	FRONT INDICATOR/ POSITION, GROMMET	20CM WITH AMP PLUG



175 Series - SIZE 175MM x 50MM x 24MM

Part No	Voltage	Function	Cable
175AW-3AMP	12V	FRONT IND FRONT POSITION	20CM WITH AMP PLUG



11 Series - SIZE 89MM x 30MM x 8MM

Part No	Voltage	Function	Cable
11CAT1M-3AMP	12- 24V	FRONT INDICATOR	25CM WITH AMP PLUG
11FWMB-3AMP	12- 24V	FRONT POSITION	25CM WITH AMP PLUG



120034 Series - 98MM x 30MM x 8MM

Part No	Voltage	Function	Cable
120034CAT1-3AMP	12V- 24V	FRONT INDICATOR	20CM WITH AMP PLUG
120034AWM-3AMP	12V- 24V	FRONT IND FRONT POSITION	20CM WITH AMP PLUG



77 Series - SIZE 77MM x 52MM x 22MM

Part No	Voltage	Function	Cable
77ACM-3AMP	12- 24V	CAT 6 SIDE DIRECTION	20CM WITH AMP PLUG
77AM-3AMP	12- 24V	CAT 6 SIDE DIRECTION	20CM WITH AMP PLUG



Hardwire Applications

Part No	Function	Cable
BBPATCH-UNI	HARDWIRE INTO VEHICLES THAT HAVE NO BBPATCH AVAILABLE FOR BULLBAR INDICATORS	85CM WITH AMP PLUG



Driving Lamp/Light Bar Patch System - Modern Vehicles with LED Headlights

Driving Lighting upgrades has never been made easier with our new plugin lamp and patch cable system. The connection requires virtually no wiring using the vehicle-specific patch cable to tap into and isolate the high beam signal. We offer an extensive range of vehicle patch cable adapters serving most popular branded vehicles, and you will be very satisfied with the options available.

- Upgrade From Globe Type
- New O/E Installation
- Save Time and Money
- Evolving Brand Compatibility
- Complete Harness Kit Available





Compatible Driving Lamps and Loom

Note: DLPATCH only gets the high beam signal. Park function requires separate wiring.



Twin Blister

7" TIR Series - SIZE 189MM X 189MM X 65MM

Part No	Voltage	Function	Cable
TIR7	12/24	DRIVING LAMP/FRONT POSITION	200MM WITH PLUG

9" TIR Series - SIZE 244MM X 241MM X 73MM

Part No	Voltage	Function	Cable
TIR9	12/24	DRIVING LAMP/FRONT POSITION	200MM WITH PLUG



Twin Blister



Twin Blister

9" DL245 - SIZE 245MM X 178MM X 109MM

Part No	Voltage	Function	Cable
DL245	12/24	DRIVING LAMP/FRONT POSITION	200MM WITH PLUG

9" DL226 - SIZE 226MM X 263MM X 114MM

Part No	Voltage	Function	Cable
DL226	12/24	DRIVING LAMP/FRONT POSITION	200MM WITH PLUG



Twin Blister

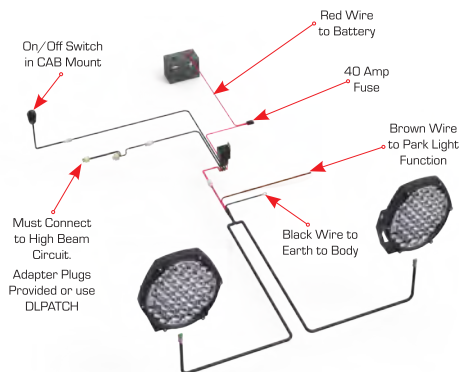

Driving Light Harness Kit SIZE 4M TOTAL LENGTH

Part No	Voltage	Function
TIRWH1	12/24	WIRING HARNESS KIT 4 METRES TOTAL LENGTH

- Includes H4 and HB3/4 Adapter
- Suitable for + or - Switched Vehicles



Part No	Function
DLPATCH-H4	DRIVE LIGHT PATCH H4 ADAPTER



Part No	Function
DLPATCH-HB34	DRIVE LIGHT PATCH HB3/HB4 ADAPTER



Category 6 - Side Direction Indicator Patch System

We have made available our most popular category six side direction indicator prewired with a suitable harness and O.E.M. vehicle connectors. A GVM upgrade or a new installation, fitting a category 5/6 approved side direction indicator to a vehicle, has never been made easier with our new plugin lamp and patch cable system.

The key is the ability to adapt to the vehicles' existing harness system. With our comprehensive range of vehicle patch cable adapter plugs suiting most popular branded vehicles, you will not be disappointed with the choice.

Compatible with the following brands

- Suits Toyota Landcruiser
- Suits Toyota HiAce
- Suits Ford Ranger
- Suits D-MAX
- Universal Adaptability





Compatible Category 6 - Side Direction Indicator Lamps

Note: ADR13/00 (F2017C01072), 6.5.3. It is permitted to replace Category 5 Side Direction-indicator lamps with Category 6 Side Direction-indicator lamps in all instances.

Our Patch Harness System allows for an easy installation of our latest 77 series Category 6 side direction indicators. To ensure the perfect drill position, we have made available the 77M magnetic template alignment tool. To install, you find the Vehicles' front indicator plug, disconnect and then install the new patch cable. The patch cable includes a quality AMP super seal plug.

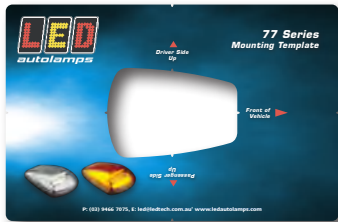

77M Fitting Guide Magnetic Template

USED TO ACCURATELY
POSITION THE LAMP

THE 77 SERIES LAMPS
ARE FITTED USING
SUPPLIED 3M TAPE &
SERRATED PLUG

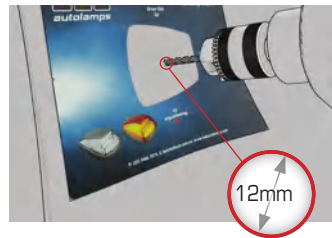

P/N: 77M

P/N: 77M-DMAX SEE PAGE 23

P/N: 77M-RANGER SEE PAGE 36

P/N: 77M-RANGER22 SEE PAGE 36

Wiring Configuration

SUITS TOYOTA
LANDCRUISER/HI-ACE,
ISUZU D-MAX

PIN	COLOUR	FUNCTION
1	WHITE	EARTH
2	-	-
3	YELLOW	INDICATOR

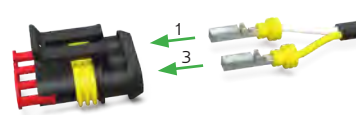

Wiring Configuration

SUITS TOYOTA HILUX

PIN	COLOUR	FUNCTION
1	YELLOW	INDICATOR
2	-	-
3	WHITE	EARTH

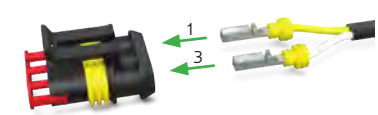

Vehicle Brand Adaptability

Explicitly designed to be easily and quickly installed without the need to cut, splice, solder, join, or tape wire joins. The patch harness system will also reduce fitting times which in turn saves fitters time and money. This comprehensive patch system is ever-expanding with new brands and adaptability to suit. We can also help with bespoke, custom O/E or specific requirements making the process entirely adaptable for your particular needs.

Section Colour Coding Key



Rear Patch Cables
See Page 4



Front Indicator
See Page 12



Driving Lamps Light Bars
See Page 14



Side Direction
See Page 16



Power Patch
See Page 38

Important Note:

Ensure you visually match the plug you require for your application with the plug pictures in this catalogue. This will avoid any mistakes in ordering.

Brands by Page No.

• Dodge	18	• LDV	21	• Toyota	28-30	• Ssangyong	36	• Iveco	51
• Mazda	19	• Isuzu	22-23, 50	• Ford	32-35	• Mahindra	36	• Hyundai	52
• Holden	20	• Mitsubishi	24-25, 55	• Jeep	36	• Volkswagen	37		
• Great Wall	21	• Nissan	26-27, 52	• Suzuki	36	• Hino	48-49		

DODGE RAM/LARAMIE/EXPRESS



Patch Application	Part No.	Picture	Notes	1500	2500	3500
 PLUGGED REAR PATCH CABLE	PATCH-RAM.UNI (INCLUDES X2 CABLES)		VISUALLY MATCH PLUGS ON AMERICAN CONVERSION VEHICLES			
 PLUGGED REAR PATCH CABLE	PATCH-RAM1500 (INCLUDES X2 CABLES)		VISUALLY MATCH PLUGS ON AMERICAN CONVERSION VEHICLES			



















MAZDA BT-50



Important Note Regarding Tail Lamp Patch:
 Second Generation 2010 to 2020 Mazda BT50
 (Produced by Ford) will use the PATCH-RANGER/BT50.

Third Generation 2020 Onwards Mazda BT50
 (Produced by Isuzu) will use the PATCH-DMAX.

Ensure you visually match the plugs before ordering.

Patch Application	Part No.	Picture	Notes	<2020	2020+
 PLUGGED REAR PATCH CABLE	PATCH-RANGERBT50.UNI (INCLUDES X2 CABLES)		BT-50 PRE MY20		
 PLUGGED REAR PATCH CABLE	PATCH-RANGERBT50 (INCLUDES X2 CABLES)		BT-50 PRE MY20		
 PLUGGED REAR PATCH CABLE	PATCH-DMAX (INCLUDES X2 CABLES)		BT-50 MY20 ONWARDS		
 DRIVING LAMPS LIGHT BAR	DLPATCH-DMAXRG (INCLUDES X1 CABLE)		MY20 ONWARDS		
 BULLBAR FRONT INDICATOR/ POSITION	BBPATCH-BT50.11 (INCLUDES X1 CABLE)		MY11-MY20 ONWARDS		
 BULLBAR FRONT INDICATOR/ POSITION	BBPATCH-BT50.20 (INCLUDES X1 CABLE)		MY20 ONWARDS		

HOLDEN COLORADO RG



Important Note:

Rear Patch Cable for the Holden Colorado RG will only work with the following rear tail lamps due to the Tail/Stop functions powered by one wire.



Suitable lamps:

- 82 Series
- 250 Series
- 275 Series
- 280 Series
- 282 Series
- 283 Series
- Maxilamp Series

Patch Application	Part No.	Picture	Notes	LTZ	Z71
 <p>PLUGGED REAR PATCH CABLE</p>	<p>PATCH-COLORADO (INCLUDES X2 CABLES WITH 12V RESISTOR)</p>		<p>ADVISE USE OF 2PM.5LP (LICENCE CAN TRIGGER CODE) SEE PAGE 9</p>	●	●
 <p>BULLBAR FRONT INDICATOR/ POSITION</p>	<p>BBPATCH-COLORADO (INCLUDES X2 CABLES)</p>		<p>LIGHTING SEE PAGE 12</p>	●	●
 <p>DRIVING LAMPS LIGHT BAR</p>	<p>DLPATCH-COLORADO (INCLUDES X1 CABLE)</p>		<p>SUITS ALL MODELS</p>	●	●





HOLDEN RODEO



Patch Application	Part No.	Picture	Notes	MY03 - MY08
 <p>PLUGGED REAR PATCH CABLE</p>	<p>PATCH-DMAX (INCLUDES X2 CABLES)</p>		<p>LIGHTING SEE PAGE 6-9. SUITS MY03-MY08</p>	●



GREAT WALL CANNON



Patch Application	Part No.	Picture	Notes	L	X
 PLUGGED REAR PATCH CABLE	PATCH-CANNON (INCLUDES X2 CABLES)				

GREAT WALL STEED



Patch Application	Part No.	Picture	Notes	4X2	4X4
 PLUGGED REAR PATCH CABLE	PATCH-STEEDSC (INCLUDES X2 CABLES)		SUITS CAB CHASSIS		

















LDV T60/T70



Patch Application	Part No.	Picture	Notes	T60	T70
 PLUGGED REAR PATCH CABLE	PATCH-LDV (INCLUDES X2 CABLES)		FITS T70 & T60 MODEL 2018 & 2019		
 DRIVING LAMPS LIGHT BAR	DLPATCH-LDVT60 (INCLUDES X1 CABLE)		SUITS LDVT60		

ISUZU D-MAX RT/RG



Patch Application	Part No.	Picture	Notes	RT	RG
 PLUGGED REAR PATCH CABLE	PATCH-DMAX.UNI (INCLUDES X2 CABLES)		LIGHTING SEE PAGE 6-9		
 PLUGGED REAR PATCH CABLE	PATCH-DMAX (INCLUDES X2 CABLES)		LIGHTING SEE PAGE 6-9		
 BULLBAR FRONT INDICATOR/ POSITION	BBPATCH-DMAX (INCLUDES X2 CABLES)		RT PRE 2020 MODELS WITH LED HEADLIGHTS		
 BULLBAR FRONT INDICATOR/ POSITION	BBPATCH-DMAXH4 (INCLUDES X2 CABLES)		HALOGEN HEADLIGHT MODELS		
 BULLBAR FRONT INDICATOR/ POSITION	BBPATCH-DMAX.12 (INCLUDES X 2 CABLE)		MY12- MY17 LS- U/M/T WITH HALOGEN HEADLIGHTS		

ISUZU D-MAX RT/RG



Patch Application	Part No.	Picture	Notes	RT	RG
 BULLBAR FRONT INDICATOR/ POSITION	BBPATCH-DMAXRG (INCLUDES X1 CABLE)		RG POST 2020 MODELS WITH LED HEADLIGHTS		
 DRIVING LAMPS LIGHT BAR	DLPATCH-DMAX (INCLUDES X1 CABLE)		RT PRE 2020 MODELS WITH LED HEADLIGHTS		
 DRIVING LAMPS LIGHT BAR	DLPATCH-DMAXRG (INCLUDES X1 CABLE)		RG POST 2020 MODELS WITH LED HEADLIGHTS		
 CAT5/6 SIDE INDICATOR LAMPS	77ACMB-DMAX (INCLUDES X1)		SEE PAGE 13 FOR 77 SERIES LAMP. SEE PAGE 15 FOR PIN CONFIGURATIONS		
 CAT5/6 SIDE INDICATOR LAMPS	77LC-LOOM (INCLUDES X1)		SEE PAGE 13 FOR 77 SERIES LAMP. SEE PAGE 15 FOR PIN CONFIGURATIONS		
 CAT5/6 SIDE INDICATOR LAMPS	77M-DMAX		SEE PAGE 17 FOR MORE INFORMATION		

MITSUBISHI TRITON MN/MQ/MR



Patch Application	Part No.	Picture	Notes	MN	MQ	MR	MV
 PLUGGED REAR PATCH CABLE	PATCH-TRITONMN.UNI SUITS DUAL CAB (INCLUDES X2 CABLES)		TRAY CONVERSION OE PLUG TO BARE WIRES	●			
 PLUGGED REAR PATCH CABLE	PATCH-TRITONMQ.UNI SUITS DUAL CAB (INCLUDES X2 CABLES)		TRAY CONVERSION OE PLUG TO BARE WIRES		●		
 PLUGGED REAR PATCH CABLE	PATCH-TRITON-MN SUITS DUAL CAB (INCLUDES X2 CABLES)		CHECK IF DOUBLE OR SINGLE CAB	●			
 PLUGGED REAR PATCH CABLE	PATCH-TRITON-MNSC SUITS SINGLE CAB (INCLUDES X2 CABLES)		SINGLE CAB WORKS FROM 92 MODEL UPWARDS	●			
 PLUGGED REAR PATCH CABLE	PATCH-TRITON-MQ (INCLUDES X2 CABLES)		SUITS MQ/MR/ MV MODELS		●	●	●
 DRIVING LAMPS LIGHT BAR	DLPATCH-TRITONMR (INCLUDES X1 CABLE)		SUITS FACTORY HID/LED HEADLIGHTS			●	







MITSUBISHI TRITON MN/MQ/MR



Patch Application	Part No.	Picture	Notes	MN	MQ	MR
 DRIVING LAMPS LIGHT BAR	DLPATCH-TRITONMQ (INCLUDES x1 CABLE)		SUITS FACTORY HID/LED HEADLIGHTS			
 BULLBAR FRONT INDICATOR/ POSITION	BBPATCH-TRITONMR (INCLUDES x2 CABLES)		SUITS FACTORY HID/LED HEADLIGHTS			
 BULLBAR FRONT INDICATOR/ POSITION	BBPATCH-TRITONMQ (INCLUDES x2 CABLES)		SUITS FACTORY LED HEADLIGHTS SEE PAGE 13			
 BULLBAR FRONT INDICATOR/ POSITION	BBPATCH-TRITONMQ.NL (INCLUDES x2 CABLES)		SUITS HALOGEN HEADLIGHTS SEE PAGE 13			

MITSUBISHI PAJERO QE/QF



Patch Application	Part No.	Picture	Notes	QE	QF
 DRIVING LAMPS LIGHT BAR	DLPATCH-PAJEROQE (INCLUDES x1 CABLE)		TO SUIT QE MODELS WITH FACTORY LED HEADLIGHTS		
 DRIVING LAMPS LIGHT BAR	DLPATCH-PAJEROQF (INCLUDES x1 CABLE)		TO SUIT QF MODELS WITH FACTORY LED HEADLIGHTS		

NISSAN NAVARA NP300



Important Note Regarding Tail Lamp Patch:

Please check vehicle build country before ordering rear lamp patch lead as plugs are different between the Thai and Spanish built models.

Ensure you visually match the plugs before ordering.

Patch Application	Part No.	Picture	Notes	Dual Cab	CabChassis
 PLUGGED REAR PATCH CABLE	PATCH-NAVARANP.UNI (INCLUDES X2 CABLES)		TO SUIT THAI MODEL	<input checked="" type="checkbox"/>	<input type="checkbox"/>
 PLUGGED REAR PATCH CABLE	PATCH-NAVARAT-NP300 (INCLUDES X2 CABLES)		TO SUIT THAI MODEL	<input checked="" type="checkbox"/>	<input type="checkbox"/>
 PLUGGED REAR PATCH CABLE	PATCH-NP300CC (INCLUDES X2 CABLES)		*FACTORY CAB CHASSIS TO SUIT THAI MODEL, MAY NEED LR ON REV.	<input type="checkbox"/>	<input checked="" type="checkbox"/>
 BULLBAR FRONT INDICATOR/ POSITION	BBPATCH-NAVARA (INCLUDES X2 CABLES)		SUIT FACTORY LED HEADLIGHTS LIGHTING SEE PAGE 12	<input checked="" type="checkbox"/>	<input checked="" type="checkbox"/>
 BULLBAR FRONT INDICATOR/ POSITION	BBPATCH-NAVARA.DRL (INCLUDES X2 CABLES)		AMP PLUG TO OE PLUGS, WITH DRL CONNECTORS LIGHTING SEE PAGE 12	<input checked="" type="checkbox"/>	<input checked="" type="checkbox"/>
 DRIVING LAMPS LIGHT BAR	DLPATCH-NAVARA (INCLUDES X1 CABLE)		WARNING MUST BE FITTED BY AUTO ELECTRICIAN DAMAGE MAY OCCUR. SUITS FACTORY LED LIGHTS	<input checked="" type="checkbox"/>	<input checked="" type="checkbox"/>

NISSAN PATROL



Patch Application	Part No.	Picture	Notes	GU	Y62
 <p>CAT5/6 SIDE INDICATOR LAMPS</p>	<p>77AMB-LCRUISER70 (INCLUDES x1 CABLE)</p>		<p>DIRECT FIT, PATCH LEAD NOT REQUIRED</p>		
 <p>CAT5/6 SIDE INDICATOR LAMPS</p>	<p>77ACMB-LCRUISER70 (INCLUDES x1 CABLE)</p>		<p>DIRECT FIT, PATCH LEAD NOT REQUIRED</p>		
 <p>DRIVING LAMPS LIGHT BAR</p>	<p>DLPATCH-PATROLY62 (INCLUDES x1 CABLE)</p>		<p>SUITS Y62 SERIES 5 ONLY</p>		

TOYOTA LANDCRUISER



Patch Application	Part No.	Picture	Notes	7X	200	300
 PLUGGED REAR PATCH CABLE	PATCH-LCRUISER.UNI (INCLUDES X2 CABLES)		OE PLUG TO BARE WIRES			
 PLUGGED REAR PATCH CABLE	PATCH-LCRUISER (INCLUDES X2 CABLES)		LIGHTING SEE PAGE 6-9			
 PLUGGED REAR PATCH CABLE	PATCH-EXTCRUISE (INCLUDES X2 CABLES)		USED TO EXTEND THE FACTORY LOOM OR O/E LIGHTING			
 PLUGGED REAR PATCH CABLE	PATCH- EXTCRUISELR1M (INCLUDES X2 CABLES)		USED TO EXTEND THE FACTORY LOOM OR O/E LIGHTING			
 PLUGGED REAR PATCH CABLE	LC300REVKIT (INCLUDES CABLE/ LAMP/BRACKET)		REVERSE LAMP/ADAPTER PATCH CABLE AND ALLOY BRACKET SEE PAGE 9			
 BULLBAR FRONT INDICATOR/ POSITION	BBPATCH-LC7X (INCLUDES X2 CABLES)					
 BULLBAR FRONT INDICATOR/ POSITION	BBPATCH-79RADAR (INCLUDES X1 CABLE)		LANDCRUISER 79 SERIES FRONT RADAR EXTENSION PATCH CABLE			



















TOYOTA LANDCRUISER



Patch Application	Part No.	Picture	Notes	7X	200
 DRIVING LAMPS LIGHT BAR	DLPATCH-LCRUISER (INCLUDES x1 CABLE)				
 CAT5/6 SIDE INDICATOR LAMPS	77AMB-LCRUISER70 (INCLUDES x1 CABLE)		DIRECT FIT, PATCH LEAD NOT REQUIRED		
 CAT5/6 SIDE INDICATOR LAMPS	77ACMB-LCRUISER70 (INCLUDES x1 CABLE)		DIRECT FIT, PATCH LEAD NOT REQUIRED		
 CAT5/6 SIDE INDICATOR LAMPS	77AMB-LCRUISER200 (INCLUDES x1 CABLE)				
 CAT5/6 SIDE INDICATOR LAMPS	77ACMB-LCRUISER200 (INCLUDES x1 CABLE)				
 CAT5/6 SIDE INDICATOR LAMPS	77ACMB-LCSAHARA (INCLUDES x1 CABLE)				
 CAT5/6 SIDE INDICATOR LAMPS	77ACM-LCR7021 (INCLUDES x1 CABLE)		CAT6 INDICATOR 21W LOAD RESISTOR		





TOYOTA HILUX



Patch Application	Part No.	Picture	Notes	MY15+	MY20+
 PLUGGED REAR PATCH CABLE	PATCH-HILUX.UNI (INCLUDES x2 CABLES)		TRAY CONVERSION OE PLUG TO BARE WIRES		
 PLUGGED REAR PATCH CABLE	PATCH-HILUX (INCLUDES x2 CABLES)		MAY REQUIRE A COMPUTER RESET		
 BULLBAR FRONT INDICATOR/ POSITION	BBPATCH-HILUX (INCLUDES x2 CABLES)		LED HEADLIGHTS		
 BULLBAR FRONT INDICATOR/ POSITION	BBPATCH-HILUXH4 (INCLUDES x2 CABLES)		HALOGEN HEADLIGHTS		
 BULLBAR FRONT INDICATOR/ POSITION	BBPATCH-HILUXN80 (INCLUDES x2 CABLES)		SUITS LED HEADLIGHTS		
 CAT5/6 SIDE INDICATOR LAMPS	77LC-L00M (INCLUDES x1 CABLE)		SEE PAGE 13 FOR 77 SERIES LAMPS		
 DRIVING LAMPS LIGHT BAR	DLPATCH-HILUXN80 (INCLUDES x1 CABLE)		SUITS LED HEADLIGHT MODELS		



TOYOTA HIACE



Patch Application	Part No.	Picture	Notes	HiAce
 CAT5/6 SIDE INDICATOR LAMPS	77LC-L00M (INCLUDES x1 CABLE)		SEE PAGE 13 FOR 77 SERIES LAMPS	
 CAT5/6 SIDE INDICATOR LAMPS	77ACMB-HIACE300 (77ACMB-LCSAHARA) (INCLUDES x1 CABLE)			







TOYOTA PRADO 150



Patch Application	Part No.	Picture	Notes	MY13+	MY18+
 BULLBAR FRONT INDICATOR/ POSITION	BBPATCH-LC7X (INCLUDES x2 CABLES)		LIGHTING SEE PAGE 13		











TOYOTA FORTUNER



Patch Application	Part No.	Picture	Notes	MY15+	MY21+
 DRIVING LAMPS LIGHT BAR	DLPATCH-FORTUNER15 (INCLUDES x1 CABLE)				
 DRIVING LAMPS LIGHT BAR	DLPATCH-FORTUNER21 (INCLUDES x1 CABLE)				

FORD RANGER/RAPTOR/ EVEREST (PX2/PX3)



Patch Application	Part No.	Picture	Notes	Ranger	RangerMY22	Raptor
 <p>BULLBAR FRONT INDICATOR/ POSITION</p>	BBPATCH-RANGER (INCLUDES X2 CABLES)		LIGHTING SEE PAGE 13 ALSO SUITS EVEREST	●		●
 <p>BULLBAR FRONT INDICATOR/ POSITION</p>	BBPATCH-RANGER22 (INCLUDES X2 CABLES)		LIGHTING SEE PAGE 13 ALSO SUITS EVEREST		●	
 <p>DRIVING LAMPS/ LIGHT BAR</p>	DLPATCH-RANGER (INCLUDES X1 CABLE)		SUITS ALL MODELS ALSO SUITS EVEREST	●		●
 <p>DRIVING LAMPS/ LIGHT BAR</p>	DLPATCH-RANGER22 (INCLUDES X1 CABLE)		SUITS RANGER22 (2 PIN QC PLUG)		●	
 <p>DRIVING LAMPS/ LIGHT BAR</p>	DLPATCH-RANGER22.1 (INCLUDES X1 CABLE)		SUITS RANGER22 (2 PIN DT PLUG)		●	

FORD RANGER/RAPTOR/ EVEREST (PX2/PX3)



Patch Application	Part No.	Picture	Notes	Ranger	RangerMY22	Raptor
 <p>CAT5/6 SIDE INDICATOR LAMPS</p>	77ACMB-RANGER (INCLUDES X1 BBIPATCH-RANGER & X1 77ACM-3AMP)		SUITS ALL MODELS ALSO SUITS EVEREST	●		●
 <p>CAT5/6 SIDE INDICATOR LAMPS</p>	77ACMB-RANGER22 (INCLUDES X1 BBPATCH-RANGER22 & X1 77ACM-3AMP)				●	
 <p>CAT5/6 SIDE INDICATOR LAMPS</p>	77M-RANGER MAGNETIC TEMPLATE FITTING GUIDE		SEE PAGE 17 FOR MORE INFORMATION	●		
 <p>CAT5/6 SIDE INDICATOR LAMPS</p>	77M-RANGER22 MAGNETIC TEMPLATE FITTING GUIDE		SEE PAGE 17 FOR MORE INFORMATION		●	

FORD RANGER/RAPTOR/ EVEREST (PX2/PX3)



Patch Application	Part No.	Picture	Notes	Ranger	Ranger MY22	Raptor
 PLUGGED REAR PATCH CABLE	PATCH-RANGERBT50.UNI (INCLUDES X2 CABLES)		ALSO SUITS EVEREST			
 PLUGGED REAR PATCH CABLE	PATCH-RANGERBT50 (INCLUDES X2 CABLES)		LIGHTING SEE PAGE 6-9 SUITS NEXT GEN RANGER CAB CHASSIS			
 PLUGGED REAR PATCH CABLE	PATCH-RANGER22 (INCLUDES X2 CABLES)		SUITS NON-SEQUENTIAL TAIL LIGHTS.(EXCEPT MAXILAMP USE PATCH-RANGER22.1)INCLUDES BLIND SPOT RADAR PLUG. SEE BELOW.			
 PLUGGED REAR PATCH CABLE	2PMLP-RANGER22		LICENCE PLUG REAR PATCH CABLE FOR RANGER22. SEE BELOW.			

2022+ NEXT GEN FORD RANGER REAR PATCH HARNESS WITH BLIND SPOT INFORMATION SYSTEM (BLIS®) RELOCATION PLUG EXTENSIONS



P/N: PATCH-RANGER22
STOP/TAIL/INDICATOR REVERSE. SUITS NON-SEQUENTIAL TAIL LIGHTS WITH BLIND SPOT RADAR PLUG.





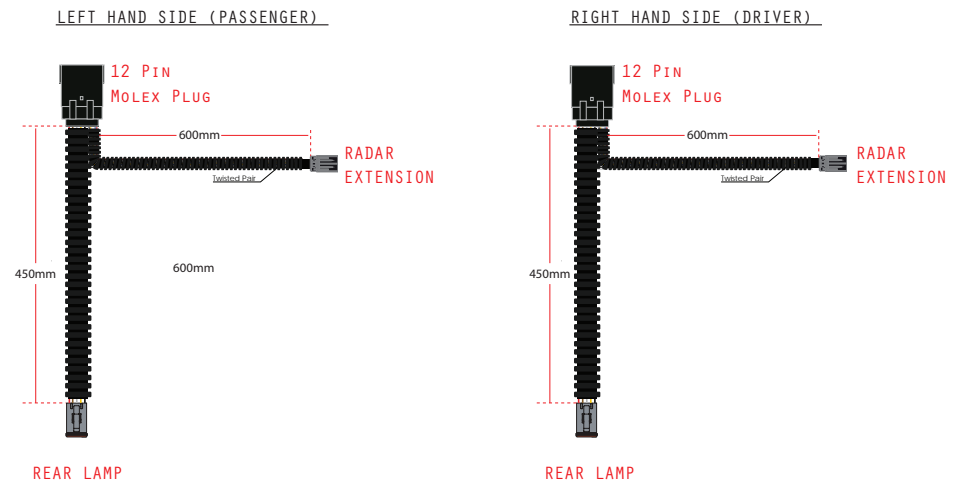







P/N: 2PMLP-RANGER22
LICENCE PLATE LAMP PLUG FOR RANGER22. INCLUDES 2 CORE MOLEX AND CSB PLUGS WITH 300MM OF CABLE.



FORD RANGER/RAPTOR/ EVEREST (PX2/PX3)



Patch Application	Part No.	Picture	Notes	Ranger	Ranger MY22	Raptor
 PLUGGED REAR PATCH CABLE	PATCH-RAPTOR (INCLUDES X2 CABLES)		LIGHTING SEE PAGE 6-9			
 PLUGGED REAR PATCH CABLE	PATCH-RANGER22.1		SUITS SEQUENTIAL (AND NON-SEQUENTIAL) TAIL LIGHTS. MAY REQUIRE PATCH-RELAY. INCLUDES BLIND SPOT RADAR PLUG AND RESISTORS. SEE BELOW.			
 PLUGGED REAR PATCH CABLE	PATCH-RELAY (INCLUDES X2 CABLES)		4-PIN RELAY WITH 450MM CABLE AND DT04-4P PLUG. SEE BELOW.			
 PLUGGED REAR PATCH CABLE	BJB4RELAY		RELAY PATCH WITH 12 PIN B4 PLUG + SOCKET. (RANGER22 SEQUENTIAL IND ISSUE FIX)			

2022+ NEXT GEN FORD RANGER REAR PATCH HARNESS WITH BLIND SPOT INFORMATION SYSTEM (BLIS®) RELOCATION PLUG EXTENSIONS



P/N: PATCH-RANGER22.1
 STOP/TAIL/SEQUENTIAL
 INDICATOR AND REVERSE.
 SUITS SEQUENTIAL TAIL
 LIGHTS WITH BLIND SPOT
 RADAR PLUG AND RESISTORS.



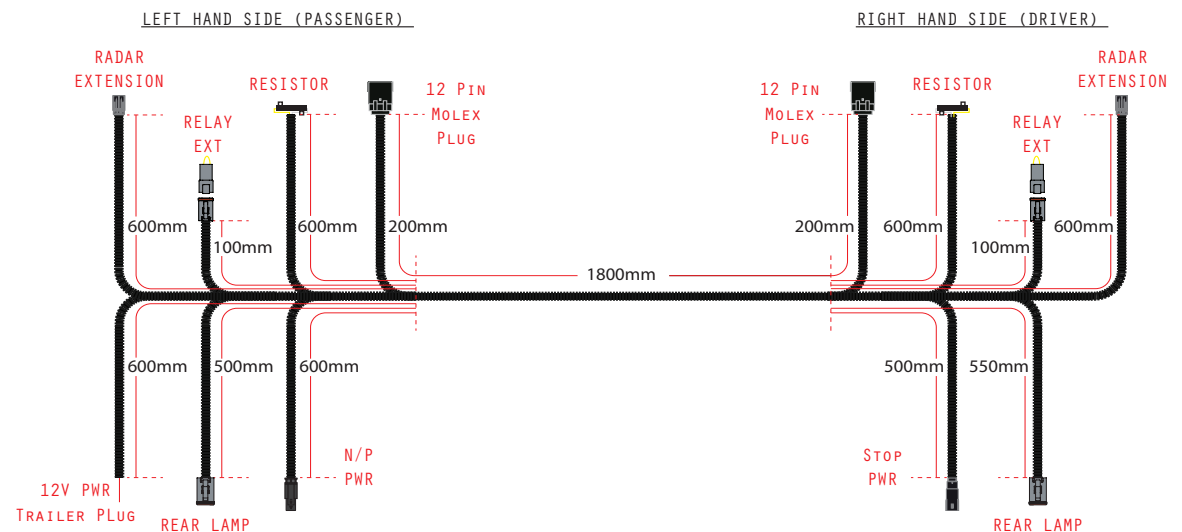

P/N: PATCH-RELAY
 4-PIN RELAY MAYBE
 REQUIRED WITH THE
 PATCH-RANGER22.1



JEEP GRAND CHEROKEE



Patch Application	Part No.	Picture	Notes	WK2
 DRIVING LAMPS LIGHT BAR	DLPATCH-GCHEROKEE (INCLUDES x1 CABLE)		FITS WK2 MODELS WITH LED/HID HEADLIGHTS	



JEEP WRANGLER/GLADIATOR



Patch Application	Part No.	Picture	Notes	JL / JT
 DRIVING LAMPS LIGHT BAR	DLPATCH-WRANGLER (INCLUDES x1 CABLE)		SUITS JL WRANGLER/JT GLADIATOR	



SUZUKI JIMNY



Patch Application	Part No.	Picture	Notes	MY18+
 DRIVING LAMPS LIGHT BAR	DLPATCH-JIMNY (INCLUDES x1 CABLE)		SUITS 2018 ONWARDS	





SSANGYONG MUSSO



Patch Application	Part No.	Picture	Notes	Musso
 PLUGGED REAR PATCH CABLE	PATCH-MUSSO (INCLUDES x2 CABLES)		LP CAN TRIGGER CODE IF NOT USED. WE ADVISE USE OF PART NO. 2PM.5LP SEE PAGE 11	

MAHINDRA S6+ / S10+



Patch Application	Part No.	Picture	Notes	S6+	S10+
 PLUGGED REAR PATCH CABLE	PATCH-MAHINDRA (INCLUDES x2 CABLES)		LIGHTING SEE PAGE 6-9		

VOLKSWAGEN AMAROK



Patch Application	Part No.	Picture	Notes	Amarok
 PLUGGED REAR PATCH CABLE	PATCH-AMAROK.UNI (INCLUDES X2 CABLES)		TRAY CONVERSION OE PLUG TO BARE WIRES	
 PLUGGED REAR PATCH CABLE	PATCH-AMAROK5LR (INCLUDES X2 CABLES)		USE PART No.2PM.5LP IF REPLACING LICENCE PLATE SEE PAGE 11	
 PLUGGED REAR PATCH CABLE	PATCH-AMAROK0LR (INCLUDES X2 CABLES)		2PM.5LP WITH THIS PATCH LEAD! - AB25/07^GOOD FOR ALL MODELS	
 PLUGGED REAR PATCH CABLE	PATCH-AMAROK23 (INCLUDES X2 CABLES)		SUITS MY23	
 BULLBAR FRONT INDICATOR/ POSITION	BBPATCH-AMAROK (INCLUDES X2 CABLES)		LIGHTING SEE PAGE 13	
 DRIVING LAMPS LIGHT BAR	DLPATCH-AMAROK (INCLUDES X1 CABLE)			



Rigid Body Harnessing System

Our research and development team continually adapt to keep up with as many vehicles as possible. The Rigid Body trucks can also benefit from this system with many possibilities to streamline your lighting and wiring options. We now offer a Power Harness that taps into the vehicles' existing harness loom, enabling fitment of our Rigid Body cable, marker kits, and accessories without time-consuming wiring. This innovative system will give you the flexibility and adaptability to compliment your O/E fitting requirements saving you time and money.

As simple as adding a trailer plug or a complete harness and lighting solution, our power harness will make ordering easy and add to your bottom line.

Compatible with the following brands

- Suits Hino
- Suits Isuzu
- Suits Mitsubishi
- Suits Hyundai
- Suits Fuso
- Suits Iveco
- Suits Nissan UD

Evolving Brand Compatibility

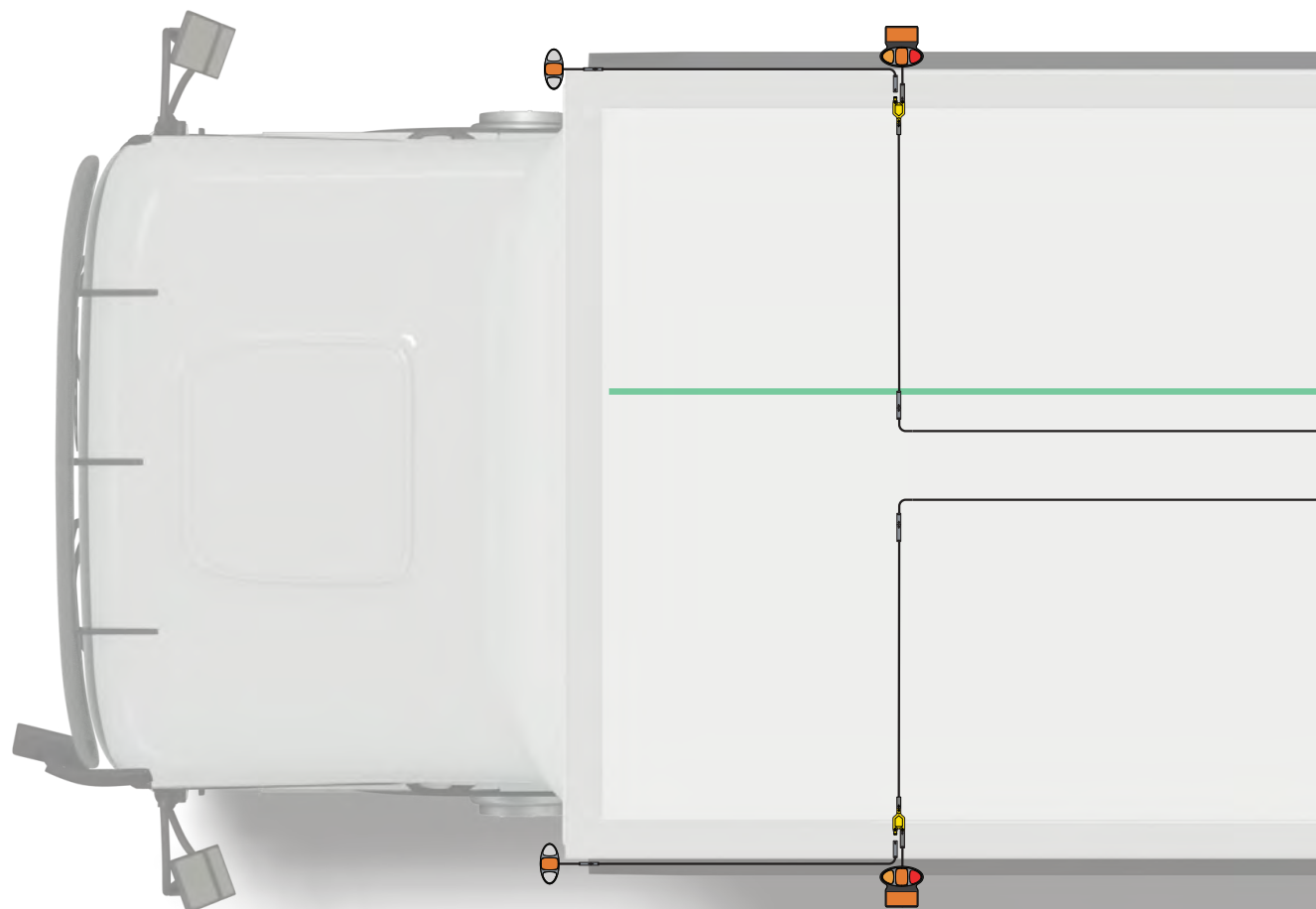

MAIN LOOM



Rigid Body Kits - Patch Into Existing Wiring Loom

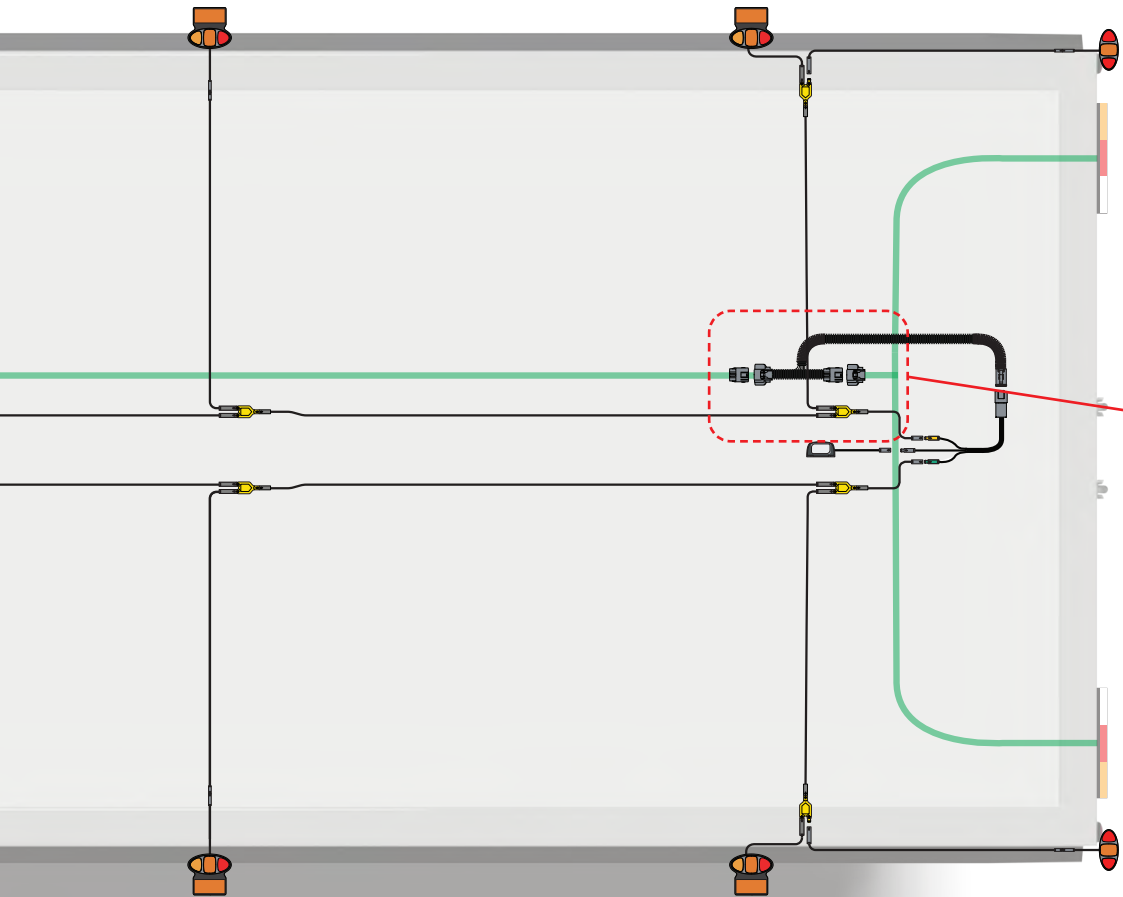

It has never been easier to tap into the vehicles' existing loom by using our innovative Patch System.

- Perfect for OEM Fitters
- Save Time & Money
- System Expandable
- System Customisable
- System Adaptability

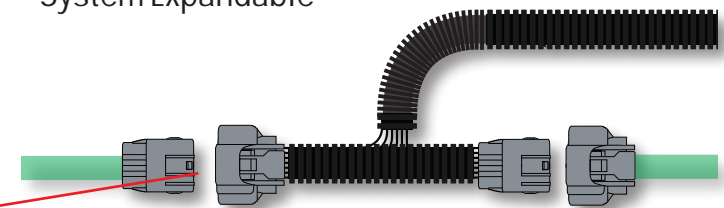

PATCHING INTO THE EXISTING LOOM USING A PPATCH POWER HARNESS

Multiple Cable Lengths to Choose From



Part No.	Length
2PMF.25B	25 CENTIMETERS
2PMF.5B	50 CENTIMETERS
2PMF1B	1 METRE
2PMF1.5B	1.5 METRE
2PMF2B	2 METRE
2PMF2.5B	2.5 METRE
2PMF3B	3 METRE
2PMF4B	4 METRE
2PMF5B	5 METRE



Part No.	Length
3PMF.2B	20 CENTIMETERS
3PMF.5B	50 CENTIMETERS
3PMF1B	1 METRE
3PMF2B	2 METRE
3PMF3B	3 METRE
3PMF4B	4 METRE
3PMF5B	5 METRE

See Pages 56-59 for Accessories

Rigid Body Add-on Kits

Part No.	Description
RBK-ADD.RM	RBK - BASE KIT ADD-ON, REAR MARKERS (42RM)
RBK-ADD.SM	RBK - BASE KIT ADD-ON, SIDE MARKERS (42ARM), 2.5M 2C EXT.
RBK-SB	RBK - SMALL BASE KIT, 4x 42ARM, 2x 42WM

Rigid Body Kits - 4 to 6 Metre TRAY

P/N: RBK-413
 SUITS: TRAY 4-6M
 LAMPS: 42 SERIES
 WIRE CORE: 2/3 CORE

PART No.	QTY
42ARMCSB	4
42AMCSB	4
3P3IMB	2
3PMF.2B	2
3PMF2B	2
3PMF3B	2
3PMF5B	2
PPATCH-RBK3C	1
3PFTIB	4

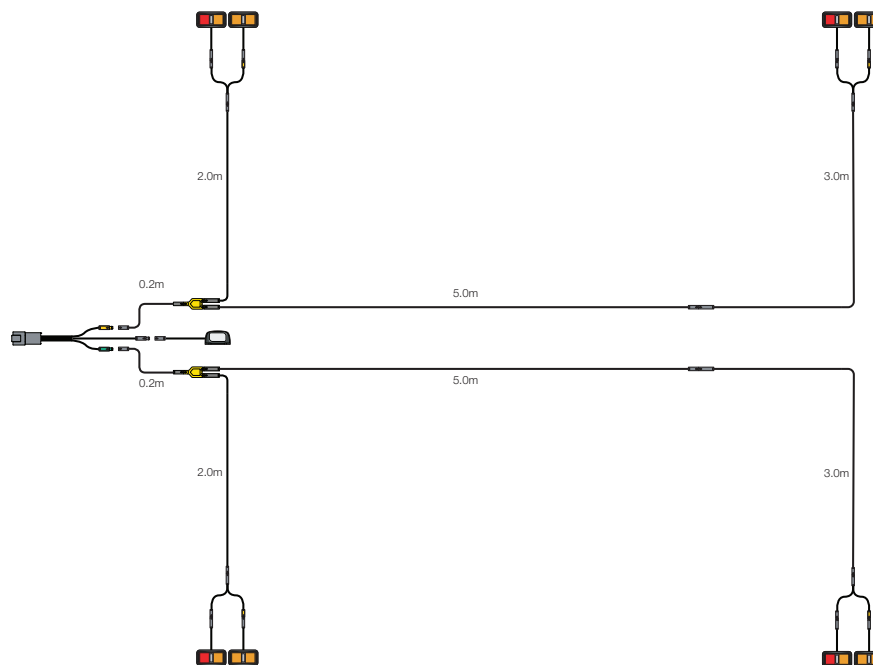

P/N: RBK-412
 SUITS: TRAY 4-6M
 LAMPS: 97 SERIES
 WIRE CORE: 3 CORE

PART No.	QTY
97CARIMCSB	4
97BKT	4
7CILR3B	1
3P3IMB	2
3PMF.2B	2
3PMF2B	2
3PMF3B	2
3PMF5B	2
PPATCH-RBK3C	1

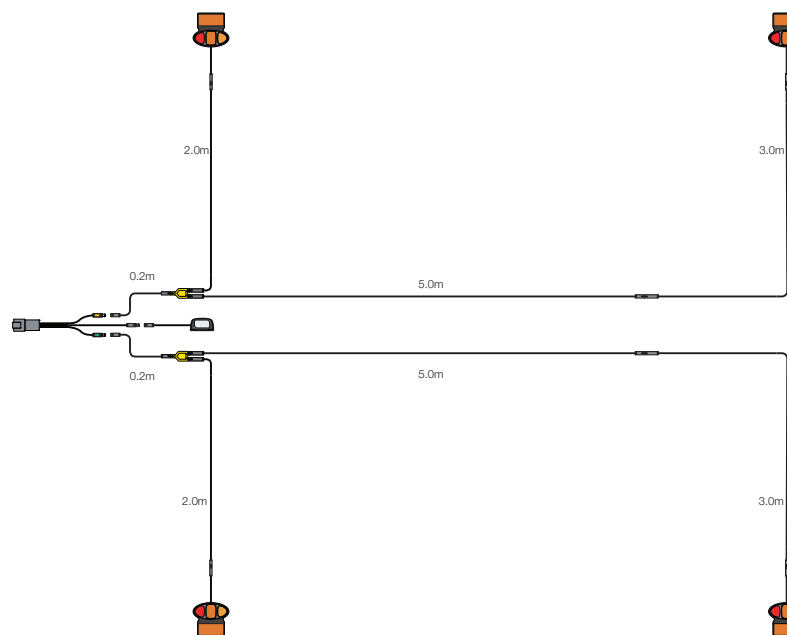

Rigid Body Kits - 4 to 6 Metre VAN



P/N: RBK-423
 SUITS: VAN 4-6M
 LAMPS: 42 SERIES
 WIRE CORE: 2/3 CORE

PART No.	QTY
42ARMCSB	4
42AMCSB	4
42WMCSB	2
42RMCSB	2
3P3IMB	2
2P3WB	4
2PCB	4
3PMF2B	2
3PMF3B	2
3PMF.2B	2
3PMF5B	2
2PMF5B	4
PPATCH-RBK3C	1
3PFTIB	4

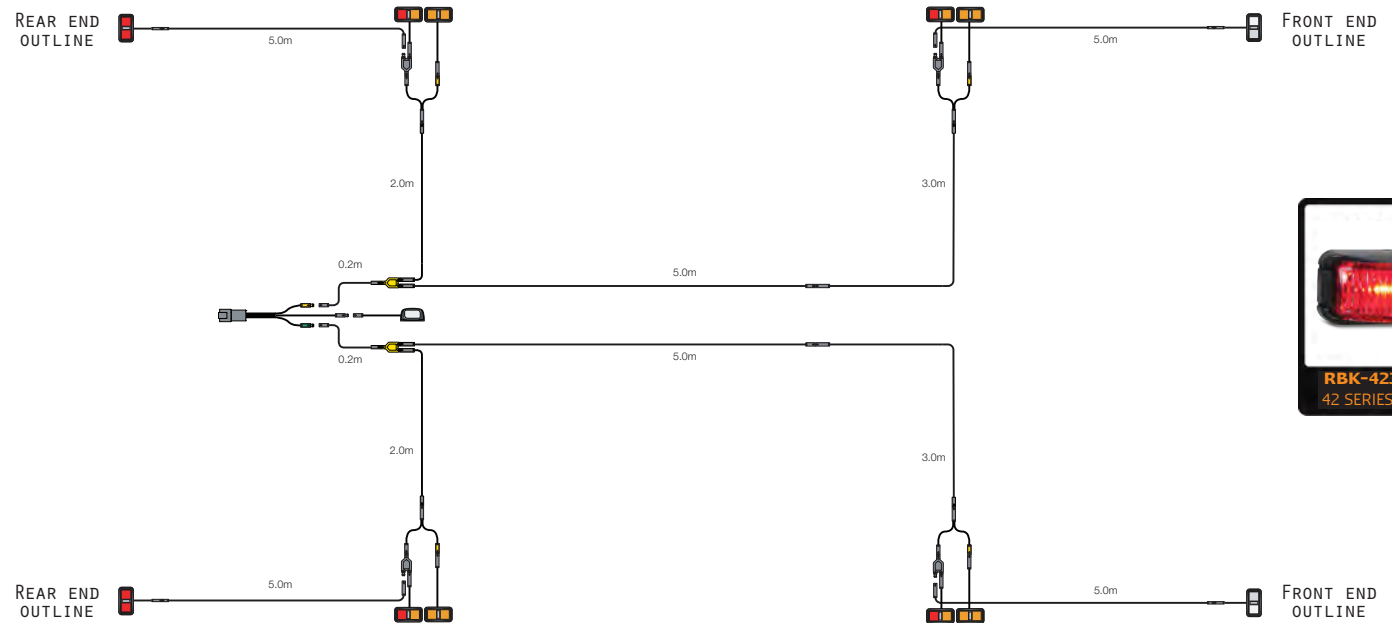

P/N: RBK-422
 SUITS: VAN 4-6M
 LAMPS: 97 SERIES
 WIRE CORE: 3 CORE

PART No.	QTY
97CARIMCSB	4
97CRIMCSB	2
97CWIMCSB	2
97BKT	4
3P3IMB	6
2PCB	4
3PMF5B	6
3PMF2B	2
3PMF3B	2
3PMF.2B	2
PPATCH-RBK3C	1

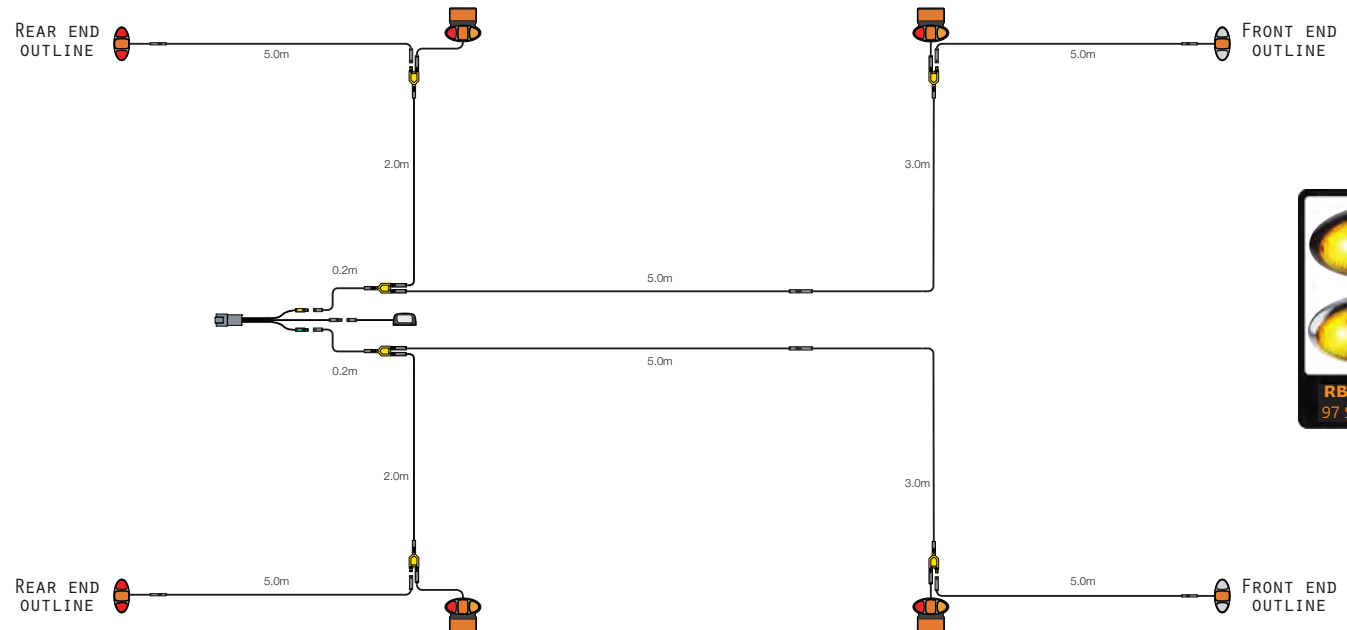

Rigid Body Kits - 6 to 9 Metre TRAY

P/N: RBK-613
 SUITS: TRAY 6-9M
 LAMPS: 42 SERIES
 WIRE CORE: 2/3 CORE

PART No.	QTY
42ARMCSB	6
42AMCSB	6
3P3IMB	4
3PMF2B	6
3PMF4B	2
3PMF.2B	2
PPATCH-RBK3C	1
3PFTIB	6

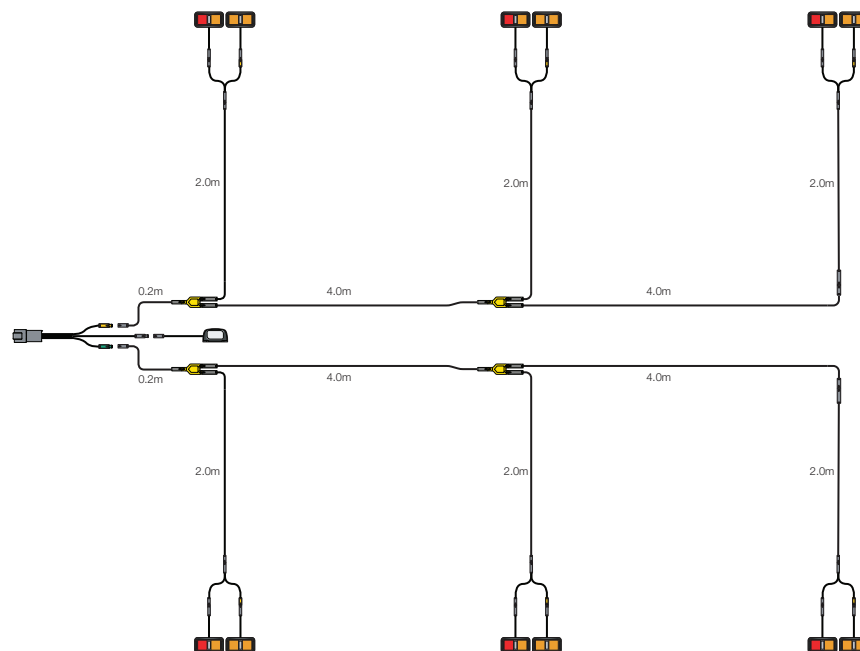

P/N: RBK-612
 SUITS: TRAY 6-9M
 LAMPS: 97 SERIES
 WIRE CORE: 3 CORE

PART No.	QTY
97CARIMCSB	6
97BKT	6
3P3IMB	4
3PMF2B	6
3PMF4B	4
3PMF.2B	2
PPATCH-RBK3C	1

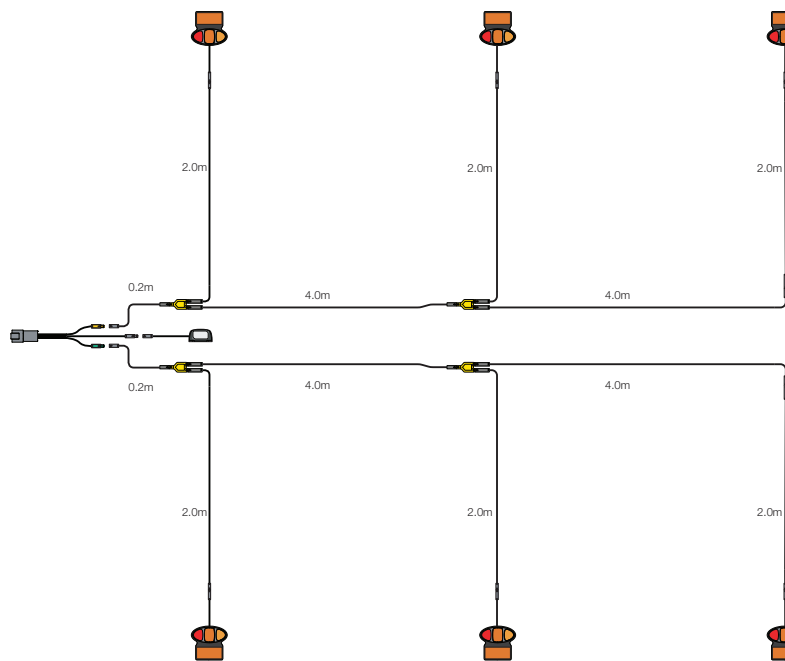

Rigid Body Kits - 6 to 9 Metre VAN



P/N: RBK-623
 SUITS: VAN 6-9M
 LAMPS: 42 SERIES
 WIRE CORE: 2/3 CORE

PART NO.	QTY
42ARMCSB	6
42AMCSB	6
42WMCSB	2
42RMCSB	2
3P3IMB	4
2P3WB	4
2PCB	4
3PMF4B	4
3PMF2B	6
3PMF.2B	2
2PMF5B	4
PPATCH-RBKT3C	1
3PFTIB	6

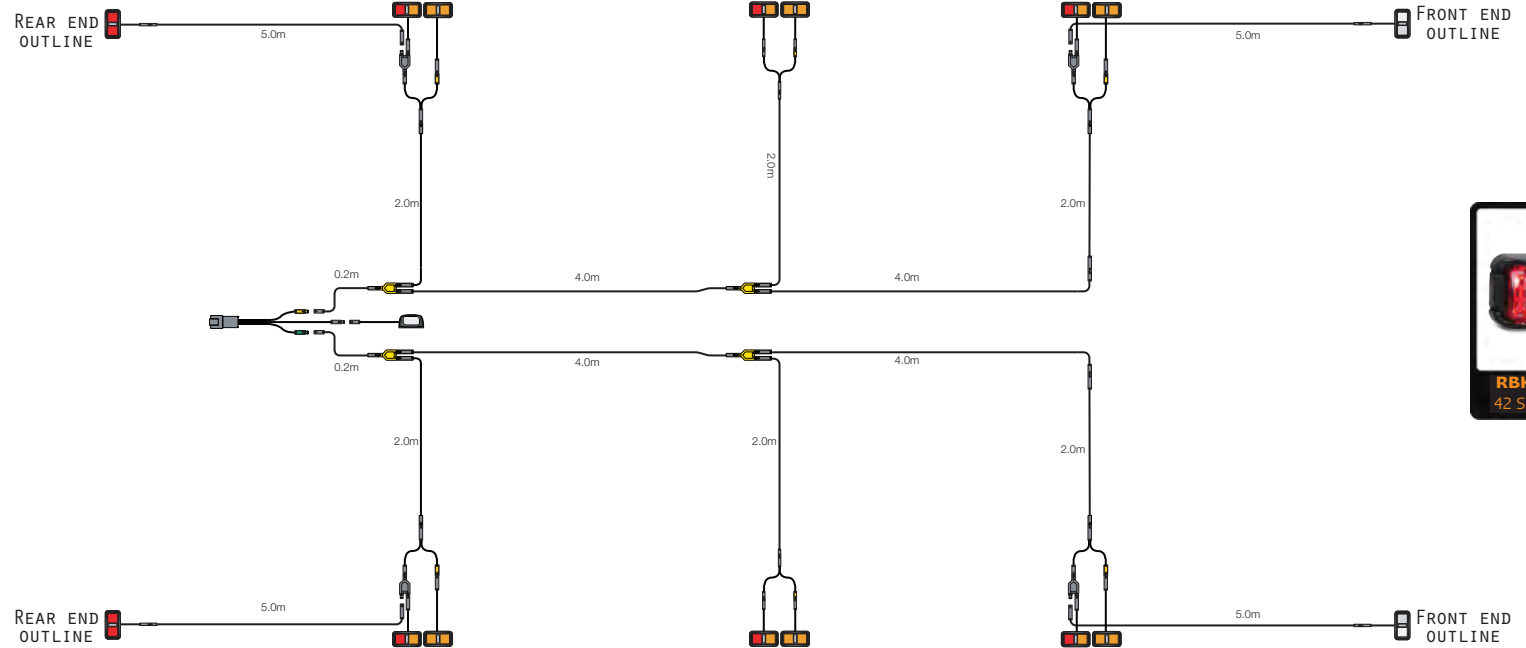

P/N: RBK-622
 SUITS: VAN 6-9M
 LAMPS: 97 SERIES
 WIRE CORE: 3 CORE

PART NO.	QTY
97CARIMCSB	6
97CRIMCSB	2
97CWIMCSB	2
97BKT	6
3P3IMB	8
2PCB	4
3PMF5B	4
3PMF4B	4
3PMF2B	6
3PMF.2B	2
PPATCH-RBK3C	1

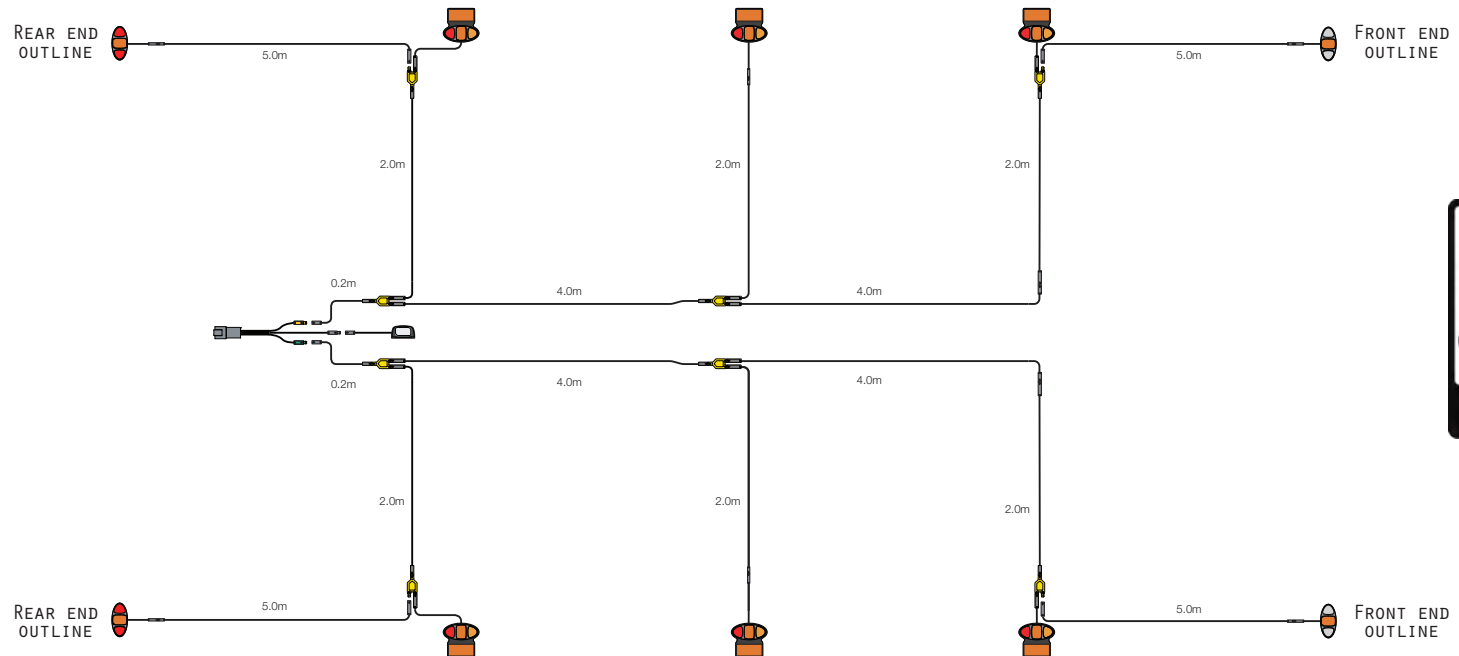

Rigid Body Kits - 10 to 12 Metre TRAY

P/N: RBK-1013
 SUITS: TRAY 10-12M
 LAMPS: 42 SERIES
 WIRE CORE: 2/3 CORE

PART NO.	QTY
42ARMCSB	8
42AMCSB	8
3P3IMB	6
3PMF2B	8
3PMF4B	6
3PMF.2B	2
PPATCH-RBK3C	1
3PFTIB	8

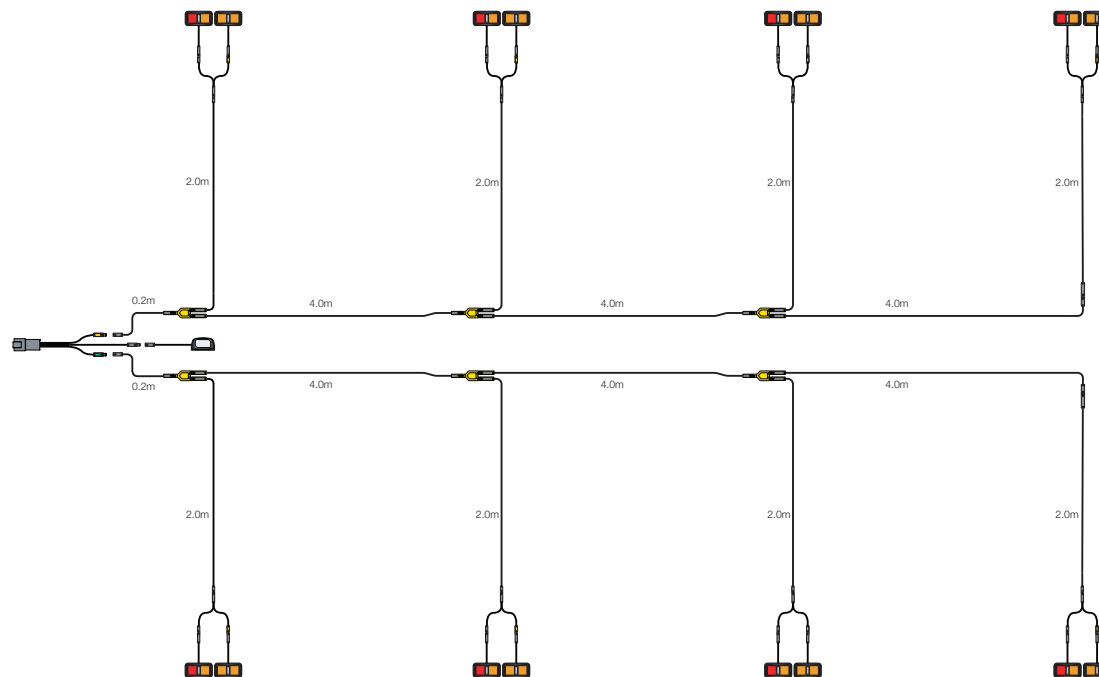

P/N: RBK-1012
 SUITS: TRAY 10-12M
 LAMPS: 97 SERIES
 WIRE CORE: 3 CORE

PART NO.	QTY
97CARIMCSB	8
97BKT	8
3P3IMB	6
3PMF2B	8
3PMF4B	6
3PMF.2B	2
PPATCH-RBK3C	1

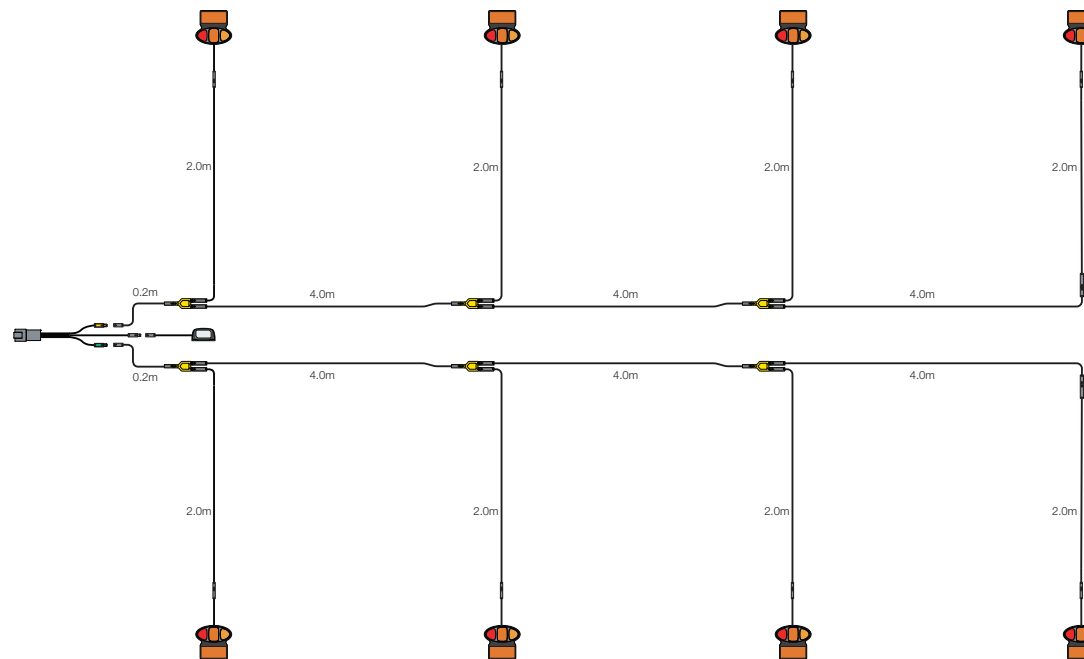

Rigid Body Kits - 10 to 12 Metre VAN

P/N: RBK-1023
 SUITS: VAN 10-12M
 LAMPS: 42 SERIES
 WIRE CORE: 2/3 CORE

PART No.	QTY
42ARMCSB	8
42AMCSB	8
42WMCSB	2
42RMCSB	2
3P3IMB	6
2P3WB	4
2PCB	4
3PMF2B	8
3PMF4B	6
3PMF.2B	4
2PMF5B	4
PPATCH-RBK3C	1
3PFTIB	8

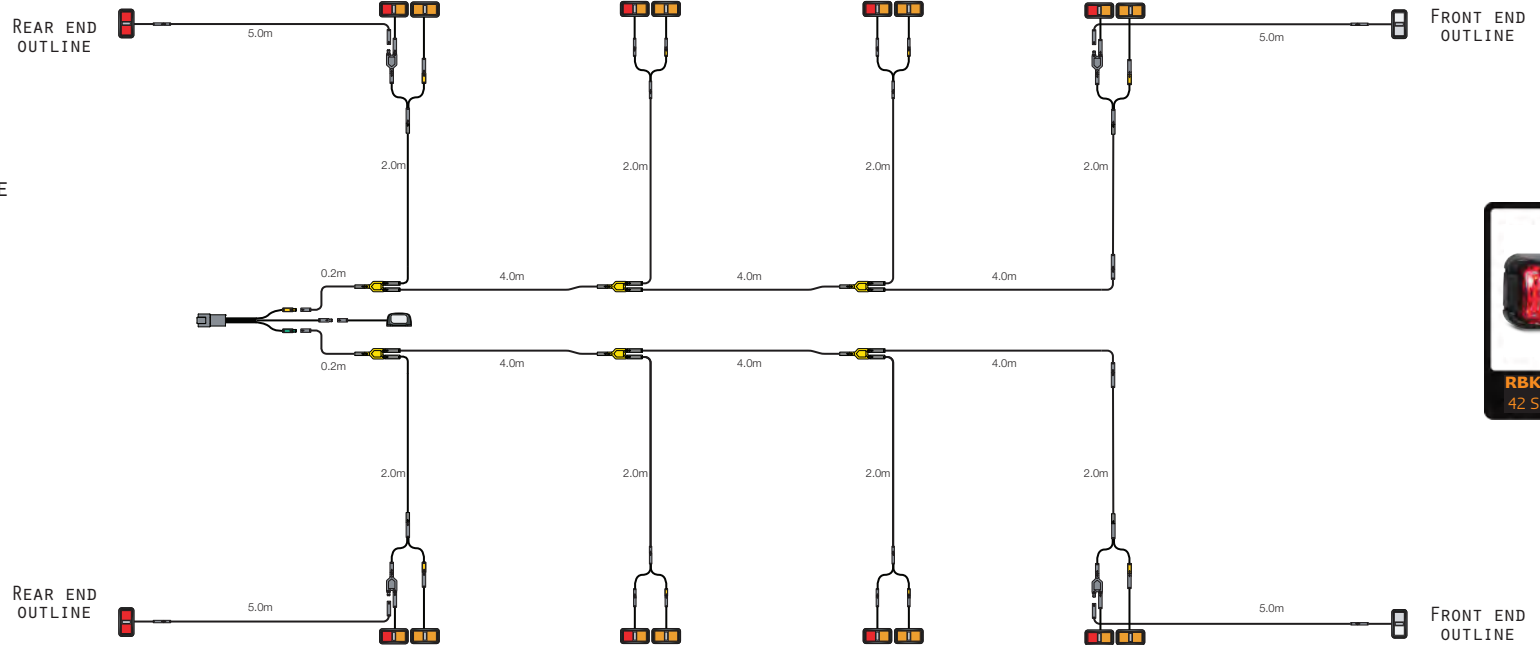

P/N: RBK-1022
 SUITS: VAN 10-12M
 LAMPS: 97 SERIES
 WIRE CORE: 3 CORE

PART No.	QTY
97CARIMCSB	8
97CRIMCSB	2
97CWIMCSB	2
97BKT	8
3P3IMB	10
2PCB	4
3PMF5B	4
3PMF2B	8
3PMF4B	2
3PMF.2B	2
PPATCH-RBK3C	1

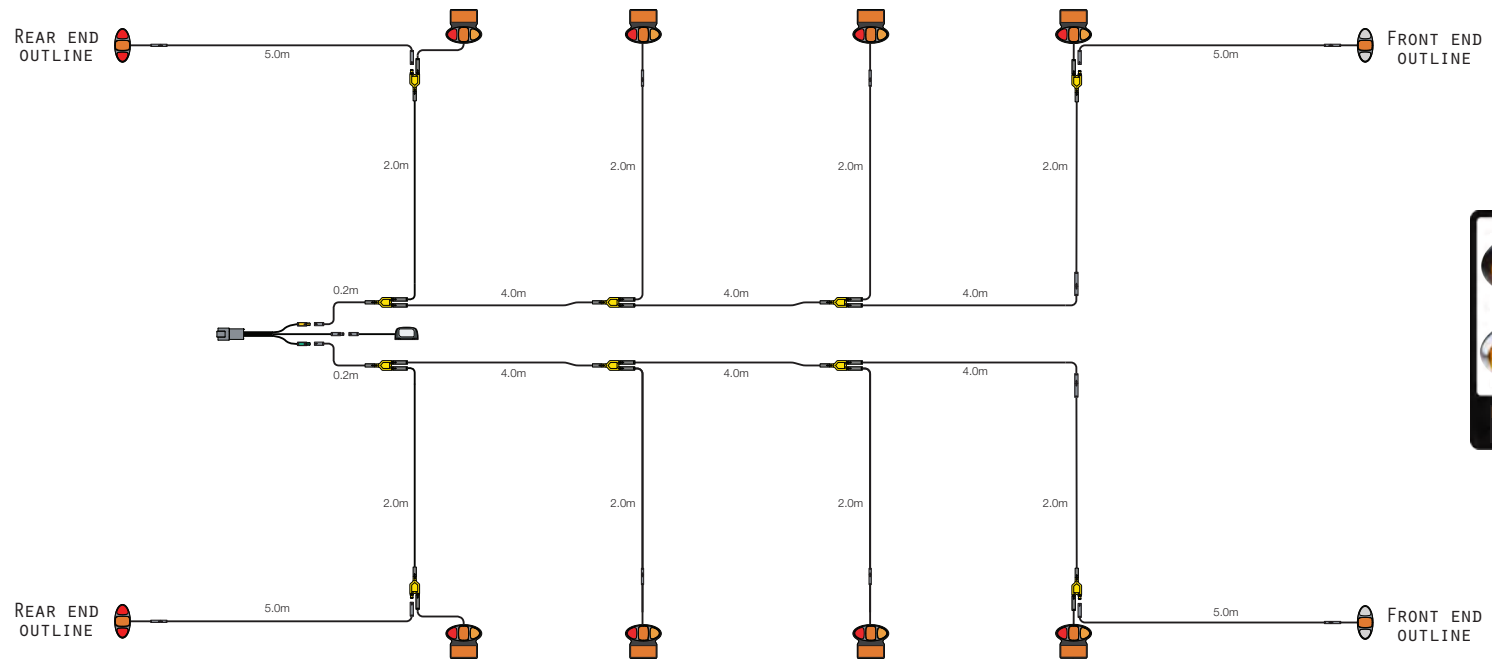



Rigid Body Kits - Break Out Patches for High Level Rear Lamps

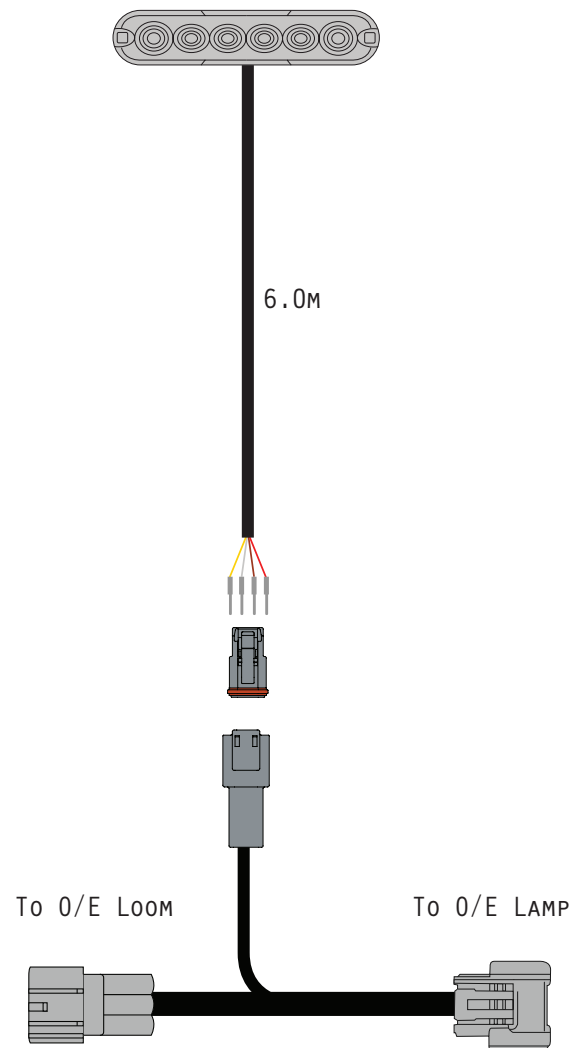

The Rigid Body trucks can also benefit from this system with many possibilities to advance your lighting and wiring options. We now offer a Break-Out Patch Cable that taps into the vehicles' existing rear lighting harness, enabling the addition of high-level combination lamps without time-consuming wiring. This innovative system will give you the flexibility and adaptability to compliment your O/E fitting requirements saving you time and money.

We have break-out patch cables to suit many Rigid Truck Brands. Moving forward, we will be working on future models. If **you require a specific application, please** do not hesitate to discuss it with your LED Autolamps representative.



Rigid Body Kits - Break Out Patches for High Level Rear Lamps



12 Series - SIZE 131MM X 30MM X 8MM

Part No	Voltage	Function/Description
12ARM6-DT04	12/24V	STOP/TAIL/INDICATOR 6M CABLE WITH 2 X DEUTSCH CONNECTOR



201 Series - SIZE 200MM X 50MM X 28MM

Part No	Voltage	Function/Description
201BSTIMDT3M (3 METRE CABLE)	12/24V	STOP/TAIL/INDICATOR 3 OR 6M CABLE WITH 2 X DEUTSCH CONNECTOR
201BSTIMDT6M (6 METRE CABLE)		



135 Series - SIZE 135MM X 38MM X 24MM

Part No	Voltage	Function/Description
135ARMDT6M	12/24V	STOP/TAIL/INDICATOR 6M CABLE WITH 2 X DEUTSCH CONNECTOR



Break-Out Patch Cable

Part No	Function/Description
SEE VEHICLE APPLICATION GUIDE	BREAKS OUT FROM THE O/E REAR PLUG.

Rigid Body - Test

WHEN USED TOGETHER,
THE TEST-BOX12V &
TEST-237CSB ALLOWS
YOU TO;

- 1) ISOLATE
- 2) DIAGNOSE
- 3) CHECK

EVERY SECTION AND
COMPONENT OF THE RBK
HARNESING KITS.



P/N:
TEST-BOX12V

FUNCTION SWITCH BOX WITH
RECHARGEABLE BATTERY
AND 3 METRES OF CABLE



P/N:
TEST-237CSB

MULTI-FIT ADAPTER TO TEST
THE HARNESS SIGNAL
FOR THE 2, 3, & 7 CORE CABLE.

USING THE TEST-LIGHTMV
MAKES IT AN EASY TASK
TO ENSURE ALL LIGHTING
OUTPUTS RECEIVED FROM
THE VEHICLE WORK
CORRECTLY. RECOMMENDED
FOR USE WITH REAR
PATCH AND POWER PATCH
HARNESSES.









P/N:
TEST-LIGHTMV

LIGHT INCLUDED TO TEST
THE VEHICLE SIGNAL

HINO



Patch Application	Part No.	Picture	Notes	Truck
 PLUGGED REAR PATCH CABLE	PATCH-HINO (INCLUDES X2 CABLES)		LIGHTING SEE PAGE 6-9	
 POWER HARNESS SYSTEM	BOPATCH-HINO. STI (INCLUDES X2 CABLES)			

HINO 300



Patch Application	Part No.	Picture	Notes	300
 PLUGGED REAR PATCH CABLE	PATCH-HINO300 (INCLUDES X2 CABLES)			
 POWER HARNESS SYSTEM	PPATCH-HINO300 (INCLUDES X1 CABLE)			
 POWER HARNESS SYSTEM	BOPATCH-H300.STI (INCLUDES X2 CABLES)			
 POWER HARNESS SYSTEM	BOPATCH-HINO.T		POWERS SIDE MARKERS BY PATCHING INTO THE O/E LICENCE PLATE LAMP HARNESS	

HINO 500



Patch Application	Part No.	Picture	Notes	FC	FD
 PLUGGED REAR PATCH CABLE	PATCH-HIN0500 (INCLUDES X2 CABLES)				
 POWER HARNESS SYSTEM	PPATCH-HIN0500 (INCLUDES X1 CABLE)		FC TIPPER & FL MODELS HAVE DIFFERENT PIN CONFIGURATIONS		
 POWER HARNESS SYSTEM	BOPATCH-H500.STI (INCLUDES X2 CABLES)				
 POWER HARNESS SYSTEM	BOPATCH-HIN0.T		POWERS SIDE MARKERS BY PATCHING INTO THE O/E LICENCE PLATE LAMP HARNESS		

HINO 700



Patch Application	Part No.	Picture	Notes	700
 PLUGGED REAR PATCH CABLE	PATCH-HIN0700 (INCLUDES X2 CABLES)			
 POWER HARNESS SYSTEM	BOPATCH-HIN0.T		POWERS SIDE MARKERS BY PATCHING INTO THE O/E LICENCE PLATE LAMP HARNESS	
 POWER HARNESS SYSTEM	BBPATCH-HIN0700 (INCLUDES X1 CABLES)			















ISUZU TRUCK



Patch Application	Part No.	Picture	Notes	N	F
 PLUGGED REAR PATCH CABLE	PATCH-ISUZU (INCLUDES X2 CABLES)		LIGHTING SEE PAGE 6-9		
 PLUGGED REAR PATCH CABLE	PATCH-ISUZUEXT (INCLUDES X2 CABLES)		USED TO EXTEND THE LOOM		
 POWER HARNESS SYSTEM	PPATCH-ISUZUN (INCLUDES X1 CABLE)		SUITS N SERIES		
 POWER HARNESS SYSTEM	PPATCH-ISUZUF (INCLUDES X1 CABLE)				
 POWER HARNESS SYSTEM	BOPATCH-ISUZU.STI (INCLUDES X2 CABLES)		SEE PAGES 38-39		
 DRIVING LAMPS LIGHT BAR	DLPATCH-ISUZUN (INCLUDES X1 CABLE)				
 DRIVING LAMPS LIGHT BAR	DLPATCH-ISUZUF (INCLUDES X1 CABLE)				





IVECO DAILY/ EUROCARGO



Patch Application	Part No.	Picture	Notes	Daily	Eurocargo
 PLUGGED REAR PATCH CABLE	PATCH-DAILY			<input checked="" type="checkbox"/>	<input type="checkbox"/>
 PLUGGED REAR PATCH CABLE	PATCH-EU			<input type="checkbox"/>	<input checked="" type="checkbox"/>
 POWER HARNESS SYSTEM	BOPATCH-DAILY.T		POWERS SIDE MARKERS USING MANUFACTURERS RECOMMENDED LOCATION.	<input checked="" type="checkbox"/>	<input type="checkbox"/>
 POWER HARNESS SYSTEM	PPATCH-EU (INCLUDES x1 KIT)			<input type="checkbox"/>	<input checked="" type="checkbox"/>
 POWER HARNESS SYSTEM	BOPATCH-EU.STI (INCLUDES x2 CABLES)			<input type="checkbox"/>	<input checked="" type="checkbox"/>
 POWER HARNESS SYSTEM	PPATCH-DAILYSM			<input checked="" type="checkbox"/>	<input type="checkbox"/>
 POWER HARNESS SYSTEM	BOPATCH-DAILY			<input checked="" type="checkbox"/>	<input type="checkbox"/>

NISSAN UD CRONER/QUON



Patch Application	Part No.	Picture	Notes	Croner	Quon
 POWER HARNESS SYSTEM	PPATCH-EU (INCLUDES x1 KIT)			<input checked="" type="checkbox"/>	<input checked="" type="checkbox"/>
 POWER HARNESS SYSTEM	BOPATCH-EU.STI (INCLUDES x2 CABLES)			<input checked="" type="checkbox"/>	<input checked="" type="checkbox"/>

HYUNDAI MIGHTY EX



Patch Application	Part No.	Picture	Notes	EX
 PLUGGED REAR PATCH CABLE	PATCH-MIGHTYEX (INCLUDES x2 KIT)			<input checked="" type="checkbox"/>
 POWER HARNESS SYSTEM	BOPATCH-MIGHTYEX.STI (INCLUDES x2 CABLES)			<input checked="" type="checkbox"/>

DAF LF/CF



Patch Application	Part No.	Picture	Notes	LF	CF
 POWER HARNESS SYSTEM	PPATCH-EU (INCLUDES X1 KIT)			●	
 POWER HARNESS SYSTEM	BOPATCH-EU.STI (INCLUDES X2 CABLES)			●	
 POWER HARNESS SYSTEM	PPATCH-DAF (INCLUDES X1 CABLE)				●
 POWER HARNESS SYSTEM	BOPATCH-DAF (INCLUDES X2 CABLES)				●

VOLVO FE/FH/FM



Patch Application	Part No.	Picture	Notes	FE	FH	FM
 POWER HARNESS SYSTEM	PPATCH-VOLVO (INCLUDES x1 KIT)			<input checked="" type="checkbox"/>	<input checked="" type="checkbox"/>	<input checked="" type="checkbox"/>
 POWER HARNESS SYSTEM	BOPATCH-VOLVO.STI (INCLUDES x2 CABLES)			<input checked="" type="checkbox"/>	<input checked="" type="checkbox"/>	<input checked="" type="checkbox"/>

SCANIA P & G9



Patch Application	Part No.	Picture	Notes	P Series	G9 Series
 POWER HARNESS SYSTEM	PPATCH-EU (INCLUDES x1 KIT)			<input checked="" type="checkbox"/>	<input checked="" type="checkbox"/>
 POWER HARNESS SYSTEM	BOPATCH-EU.STI (INCLUDES x2 CABLES)			<input checked="" type="checkbox"/>	<input checked="" type="checkbox"/>

MITSUBISHI FUSO



Patch Application	Part No.	Picture	Notes	Fuso
 <p>PLUGGED REAR PATCH CABLE</p>	<p>PATCH-FUSO (INCLUDES X2 CABLES WITH LRM)</p>			
 <p>POWER HARNESS SYSTEM</p>	<p>BOPATCH-FUSO,STI (INCLUDES X1 CABLES)</p>			
 <p>POWER HARNESS SYSTEM</p>	<p>PPATCH-FUSO (INCLUDES X1 KIT)</p>			



Rigid Body Kits - Accessories



Reverse Beeper/Squawker

Part No	Function
2PF200RAB	REVERSE BEEPER 200MM CABLE 102DB FIXED
2PF200ETB	REVERSE BEEPER 200MM CABLE 102DB FIXED
2PF200SQB	REVERSE SQUAWKER 200MM CABLE 102DB FIXED

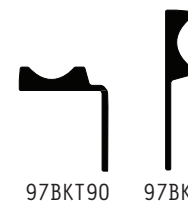

97 Series Multi-fit Bracket

Part No	Function
97BKT	MULTI-FIT BRACKET WITH AMBER REFLECTOR/RIVETS
97BKT90	90° ANGLE BRACKET WITH AMBER REFLECTOR/RIVETS



Interior/Exterior Lamp

Part No	Function
13118WM-PIR	LARGE ROUND INTERIOR/ EXTERIOR LAMP WITH PIR SENSOR



Interior/Exterior Lamp

Part No	Function
16606WM-PIR	LARGE OVAL INTERIOR/ EXTERIOR LAMP WITH PIR SENSOR



Work/Reverse Lamp

Part No	Function
7312BMCSB	FLOOD LAMP WITH 2 CORE FEMALE PLUG



Work/Reverse Lamp

Part No	Function
7512BMCSB	FLOOD LAMP WITH 2 CORE FEMALE PLUG



Rigid Body Kits - Accessories



METAL TYPE
ALSO AVAILABLE

7 Pin Large Round Trailer Sockets

Part No	Function
PPATCH-7PS	ROUND TRAILER SOCKET
PPATCH-7PSHD12	HEAVY DUTY METAL ROUND TRAILER SOCKET



METAL TYPE
ALSO AVAILABLE

7 Pin Flat Trailer Sockets

Part No	Function
PPATCH-7PFS	FLAT TRAILER SOCKET
PPATCH-7PFSHD12	HEAVY DUTY METAL FLAT TRAILER SOCKET



Licence Plate Resistor

Part No	Function
2PM.5LP	MALE T10 TO CSB PLUG (PAIR) 12V ONLY
2PM.5LPDT	2 PIN DEUTSCH PLUGS (PAIR) 12V ONLY



METAL TYPE
ALSO AVAILABLE

7 Pin Small Round Trailer Socket

Part No	Function
PPATCH-7PSRS	SMALL ROUND TRAILER SOCKET
PPATCH-7PSRSHD	HEAVY DUTY METAL SMALL ROUND TRAILER SOCKET



Voltage Reducer

Part No	Function
PPATCH-VRM	POWER PATCH WITH 10AMP VOLTAGE REDUCER 12V-24V
PPATCH-VRL	POWER PATCH WITH 20AMP VOLTAGE REDUCER 12V-24V



Universal Power Patch Cable Left/Right

Part No	Function
PPATCH-UNI.STI	POWER PATCH, JOINS LEFT & RIGHT FOR SINGLE OUTPUT



Rigid Body Kits - Accessories



Universal Power Patch Cable

Part No	Function
PPATCH-UNI	POWER PATCH FOR UNI FIT (1x 6 PIN)



Universal Power Patch Cable

Part No	Function
PPATCH-UNIDTS	POWER PATCH FOR UNI FIT (1x 6 PIN)



Trailer Lighting Module

Part No	Function
PPATCH-CANBUS	PREVENT CANBUS ERRORS WHEN CONNECTING TRAILER/CARAVAN



3 Way Power Patch Splitter

Part No	Function
BOPATCH-6P3W	3 WAY POWER PATCH WITH DT CONNECTORS



Marker Cable

Part No	Function
2PFDT04-2P	2 CORE, 250MM, CS FEMALE TO DT04-2P



RBK Adapter

Part No	Function
PPATCH-RBK7C	POWER PATCH TO RBK ADAPTER FOR 7 CORE

INCLUDED IN APPLICABLE KITS



Rigid Body Kits - Accessories



RBK Adapter

Part No	Function
3PF2PMI.2B	200MM 3 CORE TO 2 CORE INDICATOR ADAPTER CABLE



RBK Adapter

Part No	Function
3PF2PMT.2B	200MM 3 CORE TO 2 CORE TAIL ADAPTER CABLE



INCLUDED IN APPLICABLE KITS

RBK Adapter

Part No	Function
PPATCH-RBK3C	POWER PATCH TO RBK ADAPTER FOR 2&3 CORE



INCLUDED IN APPLICABLE KITS

RBK Adapter

Part No	Function
3PFTIB	200MM 3 CORE WITH 2 CORE MARKER AND 2 CORE INDICATOR EXTENSIONS



Harness Toggle Switch

Part No	Function
TSWITCH.25B	TOGGLE SWITCH 0.25M CABLE EACH SIDE
TSWITCH.5B	TOGGLE SWITCH 0.5M CABLE EACH SIDE
TSWITCH3B	TOGGLE SWITCH 3M CABLE EACH SIDE



Harness Push/Pull Switch

Part No	Function
PPSWITCH.25B	PUSH/PULL SWITCH 0.25M CABLE EACH SIDE
PPSWITCH.5B	PUSH/PULL SWITCH 0.5M CABLE EACH SIDE
PPSWITCH3B	PUSH/PULL SWITCH 3M CABLE EACH SIDE



Rigid Body Kits - Accessories System Adaptability

Power Harness
Direct to loom

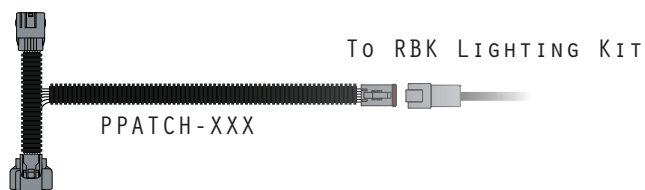

Power Harness
using 3 Way Splitter

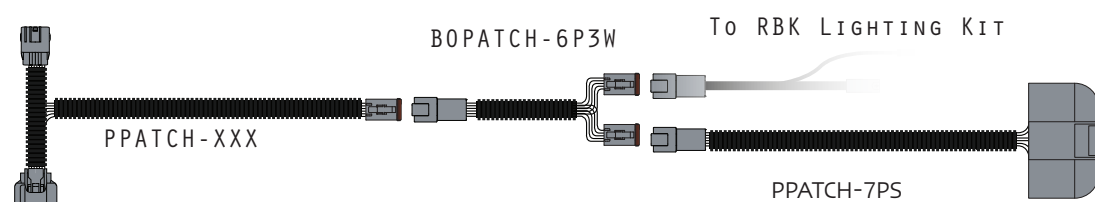

Power Harness
Direct to Trailer Plug

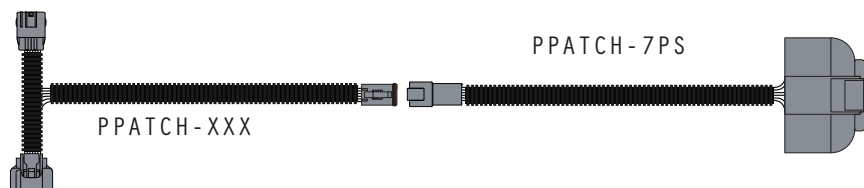

Power Harness
using 3 Way Splitter

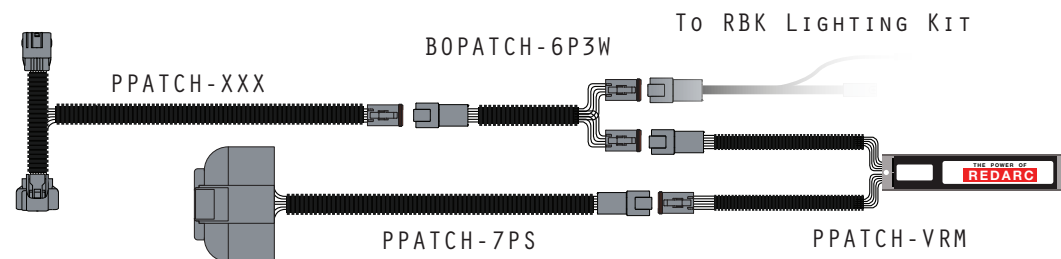

Ask your LED Autolamps representative for a solution that suits you.



Rigid Body Kits - Interior Lighting

Van Interior Kit with Pull Switch

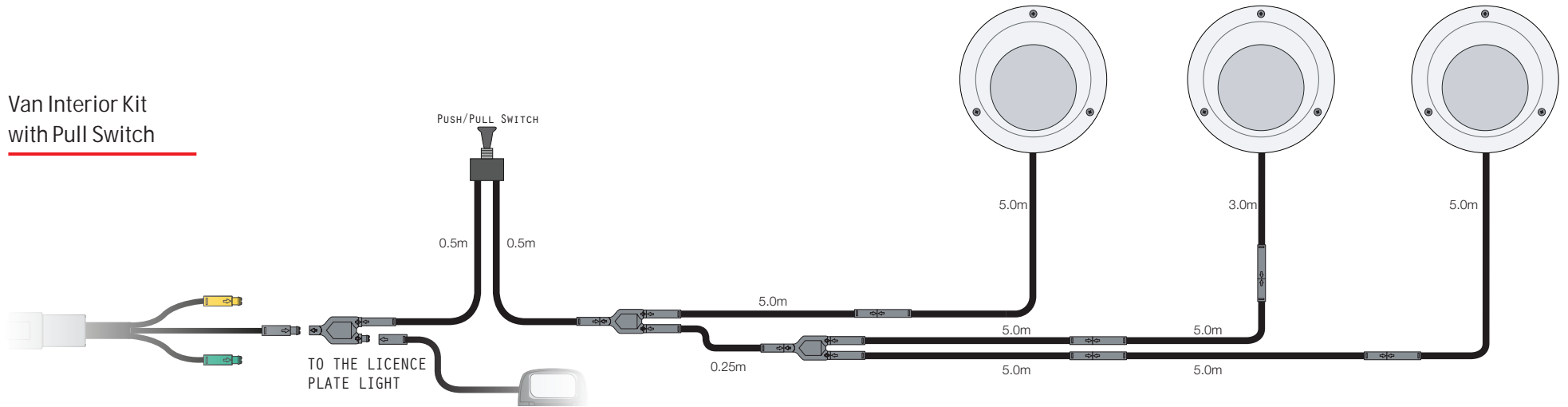

Tailgate Interior Kit with Pull Switch

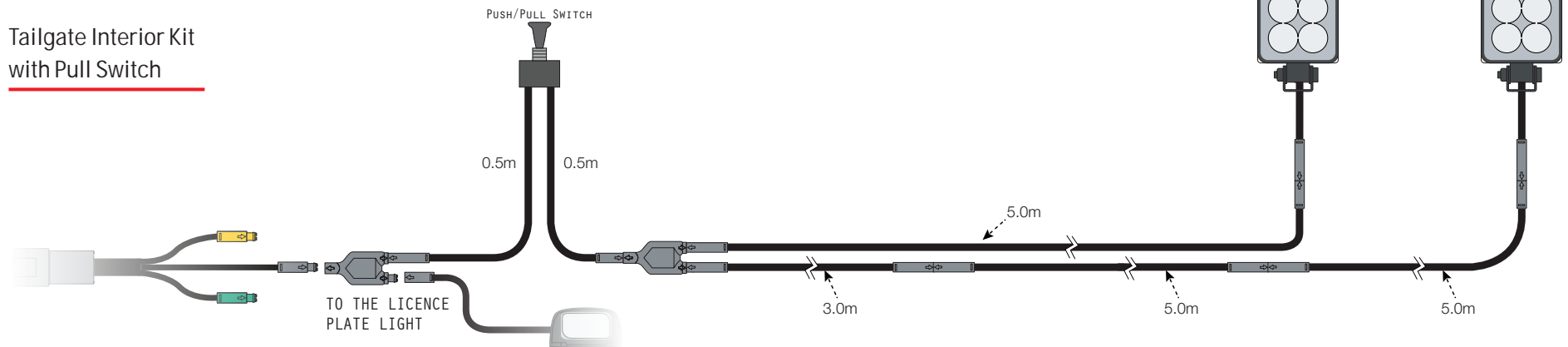

Ask your LED Autolamps representative for a solution that suits you.

Vehicle Plugs and Connectors

Part No	OEMP/N	Side	Positions	Picture
PLUG-2P7029-1	6188-0552 6918-1774	MALE	2	
PLUG-CAT6TOY-OTA	90980-11168	MALE	2	
PLUG-2P7021-1	6187-2311	MALE	2	
PLUG-2P7023-1	NULL	MALE	2	
PLUG-2P7025-1	6180-2405 90980-11155	MALE	2	
PLUG-DT04-2P	DT04-2P	MALE	2	

Part No	OEMP/N	Side	Positions	Picture
PLUG-2P7029	6185-0865	FEMALE	2	
PLUG-2P7021G	7283-7526-40 90980-11162	FEMALE	2	
PLUG-2P7021	6180-2321	FEMALE	2	
PLUG-2P7023	6189-0175 90980-11019	FEMALE	2	
PLUG-2P7025	7283-8125 6189-0249 PB195-02047 90980-11156	FEMALE	2	
PLUG-DT06-2S	DT06-2S	FEMALE	2	

Vehicle Plugs and Connectors

Part No	OEMP/N	Side	Positions	Picture
PLUG-282105-1	282105-1	MALE	3	
PLUG-DT04-3P	DT04-3P	MALE	3	
PLUG-DT04-4P	DT04-4P	MALE	4	
PLUG-FUSO	NULL	MALE	6	
PLUG-ISUZU-1	FW-C-6M-B	MALE	6	
PLUG-HILUX. LCRUISER	90980-10987	MALE	6	

Part No	OEMP/N	Side	Positions	Picture
PLUG-282087-1	282087-1	FEMALE	3	
PLUG-DT06-3S	DT06-3S	FEMALE	3	
PLUG-DT06-4S	DT06-4S	FEMALE	4	
PLUG-FUSO-1	NULL	FEMALE	6	
PLUG-ISUZU	FW-C-6F-B	FEMALE	6	
PLUG-6P7061L		FEMALE	6	

Vehicle Plugs and Connectors

Part No	OEMP/N	Side	Positions	Picture
PLUG-HIN0	6187-6561	MALE	6	
PLUG-HIN0300	6188-0175 90980-11193	MALE	6	
PLUG-DT04-6P	DT04-6P	MALE	6	
PLUG-NP300	6188-0560	MALE	6	
PLUG-6P7061-1	33482-3601 33482-0601	MALE	6	
PLUG-6P7061R	7282-7062-40 MG651104-5	MALE	6	

Part No	OEMP/N	Side	Positions	Picture
PLUG-HIN0-1	6180-6771	FEMALE	6	
PLUG-TRITONMQ	6189-0323 90980-11663 90980-11194	FEMALE	6	
PLUG-DT06-6S	DT06-6S	FEMALE	6	
PLUG-6P7069B	6185-1175 PB295-06120	FEMALE	6	
PLUG-6P7061	33472-0606	FEMALE	6	
PLUG-6P7061R-1	MG641107-5 90980-11034	FEMALE	6	

Vehicle Plugs and Connectors

Part No	OEMP/N	Side	Positions	Picture
PLUG-6P7067	7182-9331-30	MALE	6	
PLUG-DMAX	7222-7464-30	MALE	6	
PLUG-8P7089B-1.5-21B	1-1564512-1	MALE	6	
PLUG-7P3072-1.5-11B	1718230-1	MALE	7	
PLUG-8P7082B	7222-7484-30	MALE	8	
PLUG-8P7089B	6188-0738 6918-1780	MALE	8	

Part No	OEMP/N	Side	Positions	Picture
PLUG-BT50	7283-9332-30	FEMALE	6	
PLUG-6P7061B	7123-7464-30	FEMALE	6	
PLUG-8P7089B-1.5-11B	1-1670894-1	FEMALE	6	
PLUG-7P3072-1.5-21B	967650-1 1-1813344-1	FEMALE	7	
PLUG-LDV	7123-7484-30	FEMALE	8	
PLUG-8P7089B-1	6185-1179 6918-1780	FEMALE	8	



LED Autolamps

439 Boundary Road

Truganina, Victoria 3029

Phone 1800 815 000

Email led@ledautolamps.com.au

Website www.ledautolamps.com

DISCLAIMER

LED Autolamps has made every effort to ensure that the measurements and information contained in this catalogue are correct and accurate. Before orders are placed, especially before any commencement of manufacturing, please check all measurements and information. LED Autolamps reserves the right to improve, modify the dimensional design and or make technical changes or discontinue or update designs without prior notice. However, we will take all measures to inform our customers if and when possible of any changes made. LED Autolamps will not accept liability of any kind due to misuse or abuse of any products not used as intended.

**Printed May 2024
Version 5.7**